

REVIEW

Open Access



# Internal electrical fault detection techniques in DFIG-based wind turbines: a review

Abdelwahab D. Bebars, Abdelfattah A. Eladl<sup>\*</sup> , Gabr M. Abdulsalam and Ebrahim A. Badran

## Abstract

The key factor in making wind power one of the main power sources to meet the world's growing energy demands is the reliability improvement of wind turbines (WTs). However, the eventuality of fault occurrence on WT components cannot be avoided, especially for doubly-fed induction generator (DFIG) based WTs, which are operating in severe environments. The maintenance need increases due to unexpected faults, which in turn leads to higher operating cost and poor reliability. Extensive investigation into DFIG internal fault detection techniques has been carried out in the last decade. This paper presents a detailed review of these techniques. It discusses the methods that can be used to detect internal electrical faults in a DFIG stator, rotor, or both. A novel sorting technique is presented which takes into consideration different parameters such as fault location, detection technique, and DFIG modelling. The main mathematical representation used to detect these faults is presented to allow an easier and faster understanding of each method. In addition, a comparison is carried out in every section to illustrate the main differences, advantages, and disadvantages of every method and/or model. Some real monitoring systems available in the market are presented. Finally, recommendations for the challenges, future work, and main gaps in the field of internal faults in a DFIG are presented. This review is organized in a tutorial manner, to be an effective guide for future research for enhancing the reliability of DFIG-based WTs.

**Keywords:** DFIG, Wind turbines, Internal fault detection, Reliability improvement

## 1 Introduction

Wind power generation has experienced rapid expansion because of its environmental and economic benefits. It is predicted that wind power installations could reach 2110 GW by 2030 [1]. Doubly-fed induction generator (DFIG)-based units are common among various wind turbine (WT) technologies because of their advantages of only using small converters (approximately one-third of the generator rating), leading to reduced cost compared to other variable speed WTs while retaining the ability to separately control active and reactive power [2, 3]. The standard configuration of such WTs consists of a wound rotor induction generator (WRIG) with its stator connected to the grid, while the rotor is connected to a

back-to-back converter through slip-rings to operate as a DFIG, as shown in Fig. 1.

Recent surveys of wind power plants have reported several failures including internal generator (stator and rotor), electrical system, control system, drive train, sensors, gear box, mechanical brake, hydraulics, yaw system, structure, hub and blades/pitch faults [4]. Generally, the main faults of electrical machines (DFIG) can broadly be classified as stator winding faults, broken rotor bar or cracked rotor end-rings, air-gap eccentricities, bend shaft, rotor winding short-circuits, and bearing and gear-box failures [5].

The percentages of most common machine faults are shown in Fig. 2, i.e., bearing failure 40%, stator fault 38%, rotor fault 10% and all other faults 12% [6–10]. One or more of the symptoms may be associated with the incidence of these faults, such as air gap imbalance, imbalance in the induced voltages and line currents, increased

\*Correspondence: eladle7@mans.edu.eg  
Electrical Engineering Department, Faculty of Engineering, Mansoura University, El-Mansoura, Egypt

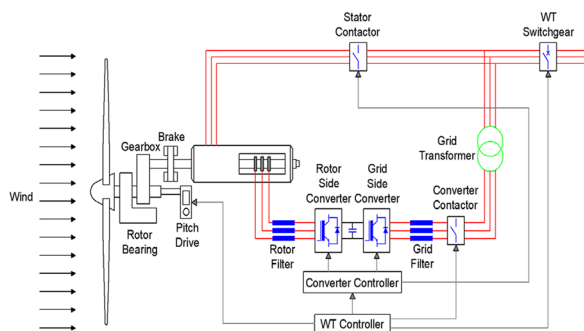

**Fig. 1** Typical configuration of wind turbines based on DFIGs

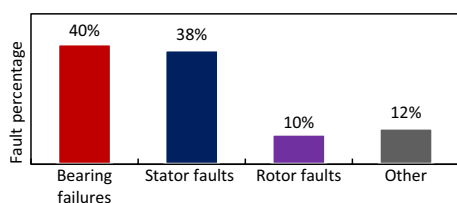
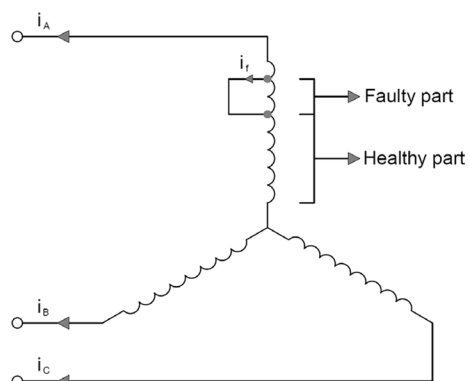

**Fig. 2** The percentage of the most common faults in DFIGs

torque pulsation, increased losses, reduction in performance, decrease in average torque, and excessive heating [5]. This work focuses on the internal faults (stator and rotor faults) of DFIG-based wind power generation units.

DFIGs usually operate in a harsh environment where they are subjected to extreme mechanical and electrical stresses. These stresses can be explained by the fact that the stator circuit is connected to a grid subjected to voltage dips and fluctuations. In the rotor circuit, the use of a back-to-back converter increases the thermal and electrical stresses on the winding because of the fast switching effect of the converter and higher-order harmonics. Internal electrical faults usually begin as insulation degradation, and some windings can be considered to be short-circuited and act like a separate coil inside the machine winding with a very high current passing through (hot spot). The stator and rotor circuits are not yet open-circuited and the machine may continue to work with this undetected internal fault as shown in Fig. 3. Thus, it is very important to detect these faults at an early stage before they turn into complete ground faults or phase-to-ground faults which in turn may cause catastrophic destruction or human injury.

In the current rotating equipment condition monitoring schemes, some symptoms in electrical machines are used for fault detection. These faults can be categorized as mechanical symptoms, e.g., vibration and speed fluctuation, and electrical symptoms, e.g., induced voltages and currents, leakage fluxes, and partial discharges [5]. Several types of sensors are used to measure these symptoms



**Fig. 3** Typical configuration of internal fault in the stator or rotor circuit

and are important parts of the detection systems. The detection of bearing faults and loose coils by monitoring the acoustic emissions is presented in [11, 12]. Vibration emissions have been used to detect mechanical faults [13], non-event air-gap [14], stator and rotor faults [15], asymmetrical power supply, and internal faults [16].

On the other hand, modern detection and monitoring systems depend on the principle of signature analysis of the machine’s phase, line, and circulating currents. The work reported in [5, 17] shows that asynchronous machine internal faults can be detected by current or power analysis, and demonstrates that power signal analysis has higher accuracy than current signal analysis [18]. The findings of this work encourage researchers to continue working on internal electrical fault detection in WRIGs based on the analysis of current or power signals [19–29]. These works vary from analyzing only experimental data, investigation based on simulation and experimental data [20–25], and theoretical explanation for the origins of fault-related components [22, 24, 26, 29]. Practical experiments are done by inserting a resistance or an inductance to machine windings to emulate an internal fault inside the machine [19, 23, 27, 28] or by actual short circuit or open circuit faults [24, 26, 29]. Variations in stator and rotor current spectral contents during an internal fault are presented in [19, 21–29], while theoretical explanations of these fault-related components are presented in [22, 24, 26, 29]. The analyses in [19–26, 29] on the other hand, concentrate on constructing a reliable fault index by analyzing both stator and rotor currents.

In this paper, findings of over 120 published papers on the detection of internal electrical faults in DFIG and developing successful engineering solutions, are reviewed. The paper starts with a general overview of the structure of DFIG for WT application. The focus will

then be directed to the various detection methods and DFIG condition monitoring techniques. A brief explanation about each type of method applied for internal fault diagnosis of DFIG is presented, and a comparison is provided to illustrate the advantages and disadvantages of each method. Figure 4 represents the sorting techniques that are used which take into consideration location and detection methods. A different sorting technique is discussed in [30], one which relies on detection methods regardless of the location of the fault, while the technique in [31] pays more attention to different methodologies beyond modeling. Reference [32] represents a sorting technique which focuses on condition monitoring system philosophy.

The main contributions of this work can be summarized as follows:

- A novel sorting technique is employed to distinguish the mathematical model used to set up the detection algorithm in each fault case. Also, it takes the location of the fault and methodology of the detection technique into consideration. The proposed sorting method helps new researchers to have a fast and deep comprehension of the topic, with the ability to move from one approach to another or from stator faults to rotor faults freely without any confusion.
- The study presents a detailed discussion on every detection technique with emphasis on the advantages and limitations of each method. The available products on the market that may be used for induction machine condition monitoring are highlighted while considering the advantages and limitations of each product.
- The study identifies the gaps that need to be filled in future research along with future trends.

The paper is organized as follows. Section 2 presents the stator internal fault detection methods, while Section 3

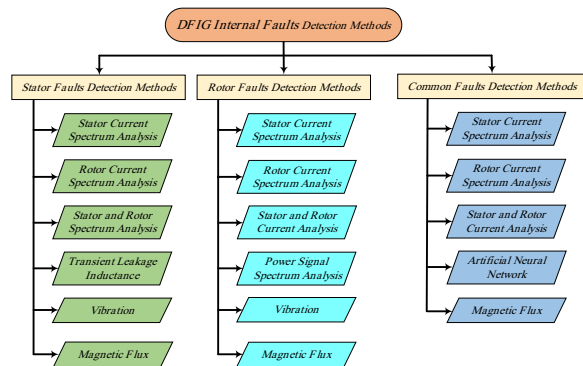

Fig. 4 Different DFIGs internal faults detection methods

presents the rotor internal fault detection methods. In Section 4, methods that can be used to detect both stator and rotor internal faults are presented. Some of the real monitoring systems available in the market are presented in Section 5, and Section 6 summarizes challenges and future trends. Finally, Section 7 offers conclusions.

## 2 Stator fault detection methods

Generally, stator winding faults can be classified as turn-to-turn shorts within a coil (inter-turn short circuit), shorts between coils of the same phase, phase-to-phase short, phase-to-ground short, and open circuit in one phase. The general opinion of users and manufacturers is that there is a long lead-time between the inception of shorted turns and a complete failure. In modern production processes, any lead time can be extremely advantageous since unexpected failures of a drive can be very costly. If an inter-turn short (one or two shorted turns) can be diagnosed, a pre-planned shutdown can be arranged and the fault can be fixed at an early stage before it becomes a complete phase-to-phase fault or phase-to-ground fault.

In this section, a comprehensive review of stator internal faults is presented including their detection parameters/techniques, and of the latest trends in the condition monitoring technology. It is aimed at providing a broad perspective on the status of stator internal fault monitoring to researchers and application engineers who are involved with DFIG-based WTs.

### 2.1 Stator current spectrum analysis

The detection of stator internal faults in synchronous and asynchronous machines is discussed in [33–35] using the extended Park’s vector approach (EPVA). Stator internal faults have been shown to be effectively detected by tracing some specific fault-related frequency components in the stator current at twice the fundamental frequency ( $2f_1$ ). The amplitudes of these fault-related components have been found to be directly related to the fault degree. A severity factor has also been presented and proven to be a good indicator of the machine condition. The machine current Park’s vector components ( $i_d, i_q$ ) as a function of phase currents ( $i_A, i_B, i_C$ ) are represented as:

$$i_d = \left(\frac{\sqrt{2}}{\sqrt{3}}\right) i_A - \left(\frac{1}{\sqrt{6}}\right) i_B - \left(\frac{1}{\sqrt{6}}\right) i_C \tag{1}$$

$$i_q = \left(\frac{1}{\sqrt{2}}\right) i_B - \left(\frac{1}{\sqrt{2}}\right) i_C \tag{2}$$

Further research is carried out in [20, 36] to apply steady-state techniques that are combinations of

machine current signature analysis (MCSA) and EPVA, in addition to a transient technique including EPVA, the discrete wavelet transform (DWT), and statistics. This technique has been found to be unaffected by wind speed fluctuations. The frequency components which may appear in the stator current spectrum as a result of an internal fault in the stator circuit are given as [37]:

$$f_{ssc} = f_1 \left[ \frac{n}{p}(1 - s) \pm k \right] \tag{3}$$

where  $f_{ssc}$  is the stator frequency,  $f_1$  is the fundamental frequency,  $p$  is the number of pole pairs,  $s$  is the slip, and  $n, k$  are integers where  $n = [1, 2, 3, \dots]$ , and  $k = [1, 3, 5, \dots]$ . Reference [38] also adopts the same detection philosophy represented in [20], though in this case the detection system only employs MCSA with a continuous wavelet transform (CWT). In this case, Eq. (3) is used to identify the fault-related components which may appear in the stator current spectrum as a result of an internal fault in the stator circuit.

A complete simulation model of DFIG based on multi-circuit theory is proposed in [23, 39]. The model shows that some frequency components which appear in the spectrum of the phase current can be used as an indicator for internal faults. The model also suggests that the fault position can be detected by checking the current phase angle difference. The mutual inductance ( $M_{ij}$ ) between two stator coils  $i$  and  $j$  under asymmetrical conditions that can be used to calculate the harmonics contained in stator current is given as:

$$M_{ij} = \frac{2N_k \tau l \mu_o}{p\pi^2 \sigma} \sum_{Z=\frac{1}{p}, \frac{2}{p}, \frac{3}{p}} \left( \frac{k_{yk}}{Z} \right)^2 \cos Z\theta_{ij} \tag{4}$$

where  $N_k$  is the number of turns in coil  $i$ ,  $\tau$  is the stator pole pitch,  $l$  is the stator effective length,  $\mu_o$  is the absolute permeability,  $\sigma$  is the air gap length,  $k_{yk}$  is the pitch factor for a coil for the  $k^{th}$  order harmonic wave,  $\theta_{ij}$  is the electrical angle between the two coils, and  $Z$  is an integer where  $Z = \frac{1}{p}, \frac{2}{p}, \frac{3}{p}$ .

An analytical model for DFIG is presented in [25] based on the coupled-circuit approach and the principles of generalized harmonic analysis along with complex conductor distribution. The proposed model calculates the self and mutual inductances with a general conductor distribution using a simplified harmonic summation. The calculation of the mutual inductance between two stator circuits and mutual inductance between stator and rotor circuits, which are helpful to identify and detect stator internal faults, is given as [40]:

$$L_{sm,sn} = L_{sn,sm} = \frac{\mu_o l_{eff} \pi d^3}{2g_{eff}} \operatorname{Re} \sum_{v=1}^{\infty} \frac{\bar{c}_{sm}^v \bar{c}_{sn}^v}{v^2} \tag{5}$$

$$M_{sm,rn} = M_{rn,sm} = \frac{\mu_o l_{eff} \pi d^3}{2g_{eff}} \operatorname{Re} \sum_{v=1}^{\infty} \frac{k_{sk}^v}{v^2} \bar{c}_{sm}^v \bar{c}_{rn}^v * e^{-j\nu\theta} \tag{6}$$

where  $L_{sm,sn}$  and  $L_{sn,sm}$  are the mutual inductances between circuit  $m$  and  $n$  in the stator,  $l_{eff}$  is the effective stack length,  $d$  is the mean air gap diameter,  $g_{eff}$  is the effective air gap length, and  $\bar{c}_{sm}^v, \bar{c}_{sn}^v$  are the  $v^{th}$  harmonic complex conductor distribution of the  $m^{th}$  and  $n^{th}$  in the stator circuits, respectively. These are determined by summing the contributions of all of the coils in that circuit.  $M_{sm,rn}$  and  $M_{rn,sm}$  are the mutual inductances between the stator and rotor circuits and vice versa,  $\theta$  is the angular displacement of the rotor in mechanical radians, and  $k_{sk}^v$  is the  $v^{th}$  harmonic skew factor. Subscripts  $s$  and  $r$  indicate stator and rotor coils, respectively.

An enhanced DFIG model with stator fault is presented in [41] using constant matrices, and a detection algorithm based on wavelet analysis for the stator current and energy is proposed. The fault severity factor (FSF) defined in the algorithm is given as [42]:

$$FSF = \frac{E_m(f)}{E_o(f)} \tag{7}$$

where  $E_m(f)$  is the measured wavelet signal energy at a certain detail level, and  $E_o(f)$  is the original signal energy.

The identification and location of stator internal faults at different slots are presented in [43]. The modified fault model is developed based on 2D discretization and piecewise interpolation, by taking the short-circuit number and position of the short-circuit slot as model parameters. Simulations show that the three-phase stator currents are no longer symmetrical when an inter-turn short circuit fault (ITSCF) occurs, where the faulty-phase current is greater than the healthy ones. Moreover, ITSCF induces a negative sequence current that increases with the gravity of the fault in the DFIG stator. Commonality and heterogeneity existing in the current amplitude and negative sequence features are proposed and analyzed for detecting stator inter-turn faults at different slots of the DFIG. The Fourier expansion formula of the magnetomotive force ( $F(\alpha, t)$ ) of the single-turn coil concluded by strict derivation is written as [43]:

$$F(\alpha, t) = \frac{\sqrt{2}I_g}{\pi p} \sum_{\vartheta} \frac{1}{\vartheta} k_{yf} \cos(\omega t \pm \vartheta \alpha_y) \tag{8}$$

$$k_{yf} = \sin(\vartheta \alpha_y / 2) \tag{9}$$

where  $I_g$  is the current flowing through stator windings,  $k_{yf}$  is the coil pitch factor,  $\alpha_y$  is the space electrical angle between two conductors, and  $\vartheta = 1/p, 2/p, 3/p, \dots$  for short pitch coils,  $\vartheta = 1/p, 2/p, 3/p, \dots, \vartheta \neq 2, 4, 6, \dots$  for full pitch coil windings, and  $\omega = 2\pi f_1$  is the angular frequency of the supply.

Based on the stationary reference frame, references [44, 45] use the state-space model of DFIG in the detection of internal faults. The proposed diagnosis technique has the advantage of enabling fault detection, identifying the faulty phase and fault level. The open-loop feedback of the linear Kalman filter (LKF) is used in this technique, while the linear parameter varying (LPV) model is found useful during hardware implementation to minimize processing time. By diagnosing the small and high levels of ITSCF, the proposed technique is effective and reliable for detecting internal stator faults. The proposed detection approach is achieved by analyzing stator current residual signals, which can be defined as the estimated errors between the currents given by the model and the currents estimated by the LKF, based on the fact that the established model of DFIG is an LPV model [46]. The mathematical formula used to calculate the residual signals ( $\Delta_{is,\alpha\beta}$  and  $\Delta_{ir,\alpha\beta}$ ) are given as [47]:

$$\Delta_{is,\alpha\beta} = \hat{i}_{s,\alpha\beta} - i_{s,\alpha\beta} \tag{10}$$

$$\Delta_{ir,\alpha\beta} = \hat{i}_{r,\alpha\beta} - i_{r,\alpha\beta} \tag{11}$$

where  $\hat{i}_{s,\alpha\beta}$  and  $\hat{i}_{r,\alpha\beta}$  are the respective stator and rotor currents estimated by LKF, and  $i_{s,\alpha\beta}$  and  $i_{r,\alpha\beta}$  are the respective stator and rotor currents estimated by the LPV model.

An analytical and experimental study for the detection of stator internal faults with a focus on their effects on DFIGs is presented in [48]. A variable resistance is inserted into the stator circuit to model an internal fault, and several values of resistance are used to model the different fault levels to analyze the effect of fault level on the detection system. The results are analyzed by the MCSA method to confirm the sensitivity of the proposed technique. They show that MCSA can be regarded as a reliable tool for preventive maintenance for internal faults at an early stage to prevent complete machine destruction. The specific fault-related harmonics that may appear in the stator current because of a stator internal fault can be calculated using (3).

### 2.2 Rotor current spectrum analysis

Further research has been conducted to detect stator faults in DFIGs using the principle of search-coil voltage [24, 49]. Results show that harmonics induced in the rotor circuit can be used as a reliable index to detect

stator faults by tracing some specific components in the rotor circuit, such as phase current and rotor search-coil voltage. It is shown that the search-coil voltage can provide an accurate index for stator internal faults [50]. The following equations represent the orders of the harmonic components that may appear in the rotor circuit because of a stator fault:

$$f_{ssc} = n_1(1 - s)f_1 \pm f_1 \tag{12}$$

$$f_{rsc} = n_1(1 - s)f_1 \pm sf_1 \tag{13}$$

where  $f_{ssc}$  and  $f_{rsc}$  are respectively the harmonic order induced in the stator current and rotor current due to internal stator short circuit fault, and  $n_1$  is an integer given as  $n_1 = 1, 6m_1 \pm 1 (m_1 = 1, 2, 3, \dots)$ .

Because discrimination between normal and abnormal stator operating conditions cannot be achieved by traditional Fourier analysis as it consumes long time and requires large computational memory, a wavelet-based analysis of rotor currents is proposed in [51] to detect stator faults. This technique shows that the mean power signal can be used as a reliable diagnostic index to quantify the fault level.

ITSCF and winding resistive asymmetrical faults are modeled in [52] using a complete magnetic equivalent circuit (MEC). The investigation aims to use the rotor reference voltage signals inside the back-to-back converter to distinguish between these types of faults. DWT with normalized energy technique is applied to the given signals to define a fault diagnostic index (FDI). The accuracy of the proposed FDI is tested under different conditions such as low number of stator shorted turns, different severities of winding resistive asymmetrical faults, different levels of grid voltage imbalance, different rotor speeds, and different output active power. The normalized energy coefficient ( $E_{j\_Norm}^D$ ) used to calculate FDI can be mathematically represented as [53]:

$$E_{j\_Norm}^D = \frac{E_j^D}{E_{avg}} \tag{14}$$

$$E_j^D = \sqrt{\frac{1}{N_j} \sum_{i=1}^{N_j} (D_j)^2 [i]} \tag{15}$$

where  $j$  is the decomposition level and  $N_j$  is its data length given as  $N_j = N/(2^j)$ , with  $N$  being the length of the discrete signal.  $i$  is an integer  $i = 1, 2, 3, \dots, N_j$ , and  $D_j$  is the DWT detail coefficient for the  $j^{th}$  decomposition level.  $E_{avg}$  is the average energy reference which can be determined by measuring the average of  $E_j^D$  using (15) for the rotor reference voltage space-vector magnitude

signals at three output active power levels (no load, 50% rated, and full load) delivered from DFIG under healthy winding conditions. Comparing the normalized energy of coefficient D5 or D6 leads to diagnosis of healthy conditions from the other stator winding fault conditions. FDI can be mathematically expressed as:

$$FDI = E_{5, Norm}^D / E_{6, Norm}^D \tag{16}$$

The results show that FDI is greater than 1 under ITSCF, and less than 1 under a winding resistive asymmetrical fault and grid voltage imbalance conditions.

Reference [54] investigates the detection of stator faults using rotor current spectrum analysis. A complete finite element model (FEM) is presented which shows that two harmonic components  $(2 - s)f_1$  and  $(2 + s)f_1$  in the rotor current increase with the occurrence of the stator fault. As the fault gets worse these two components show a rapid increase. Between the two frequencies, the increase of  $(2 - s)f_1$  is more prominent, and thus it can be employed as an effective fault indicator owing to its high sensitivity.

Rotor spectrum analysis along with rotor power waveform is discussed in [55]. The main advantage of this technique is that external sensors and hardware devices are not required as the rotor power can be measured using the back-to-back converter’s built-in sensors. In addition, the fault can be detected using a characteristic frequency of  $2f_1$  which does not depend on the rotor speed, indicating high reliability even under rotor speed fluctuations. The simulation shows that during a stator internal fault, the rotor instantaneous power spectrum changes significantly while the rotor current and voltage spectrum change insignificantly.

Rotor speed is used in [56] to detect stator faults based on an observer fault detection technique. The asymptotic and exponential adaptive observers are investigated in this study which shows that the fraction of short-circuited windings can be well calculated by both observation techniques, while the exponential technique shows a better transient performance. The exponential adaptive observer is modified to detect the fault degree and rotor speed in case the rotor speed is inestimable but additional tuning may be required to improve the transient performance of speed estimation. The technique is tested on both steady-state and transient operations, and it is found that this observer-based strategy can provide accurate estimation of stator internal faults regardless of the operating condition of the generator.

### 2.3 Stator and rotor current spectrum analysis

Reference [57] introduces a monitoring and diagnostic technique for the detection of stator faults using DWT

under time varying conditions in two main different contexts: transient-speed conditions and fault-varying conditions. A frequency sliding (FS) approach with a high multi-resolution analysis is proposed to improve the ability of DWT in extracting the most relevant stator fault frequency component dynamically over time. Also, a dynamic mean power calculation at different resolution levels is introduced as a diagnostic index to quantify the fault extent.

Diagnosis of a stator winding fault for DFIG based on stator current negative-sequence component, using the phase angle difference between phase currents and rotor power spectrum, is proposed in [58, 59]. Because the rotating magnetic field in the positive rotation induces positive-sequence current and in the negative rotation induces negative-sequence current, when a short circuit fault occurs, the negative-sequence stator current will be generated. Consequently, the negative-sequence stator current can be regarded as a reliable index for stator internal faults in DFIG. Equation (8) is used to calculate the Fourier series analysis of the rotating magnetomotive force.

### 2.4 Transient leakage inductance

Based on the  $dq$  model of DFIG, another detection technique using the induced voltages of magnetizing inductance and currents from both the stator and the rotor, is proposed in [60]. Results confirm that the proposed algorithm can detect an internal fault in stator windings if the difference between the estimations of the two induced voltages exceeds a specific value. The results also show that the proposed algorithm issues the trip command instantaneously after the internal faults are detected. This is different to the case of transient states or external faults, where no trip command is issued. This technique has shown good reliability and accuracy under different fault and operating scenarios. The detectors of the d-axis ( $\nabla_d$ ) and the q-axis ( $\nabla_q$ ) for fault detection are given as:

$$\nabla_d = \frac{v_d^r - v_d^s}{\sqrt{2}V_d} \times 100\% \tag{17}$$

$$\nabla_q = \frac{v_q^r - v_q^s}{\sqrt{2}V_q} \times 100\% \tag{18}$$

where  $v_d^r$  and  $v_d^s$  are the RMS values of the induced voltages from the rotor and stator sides in the direct axis, respectively.  $v_q^r$  and  $v_q^s$  are the RMS values of the induced voltages from the rotor and stator sides in the quadrature axis, respectively.  $V_d$  and  $V_q$  are the RMS values of  $v_d^s$  and  $v_q^s$  at steady state, respectively.

Reference [61] proposes an alternative method for detecting stator faults in DFIG by applying two short

voltage pulses with the same duration but in opposite directions to the stator windings. Analyzing the current responses during these pulses can be used to calculate the machine transient leakage inductance and detect stator faults, by considering:

$$\frac{di_{R,I-II}}{dt} = \frac{v_{R,I-II}}{l_l} = \gamma_l v_{R,I-II} \tag{19}$$

where  $i_{R,I-II}$  is the induced rotor current,  $v_{R,I-II}$  is the vector of the applied voltage, and  $l_l$  is the leakage inductance. The voltage difference phasor can be assumed constant during each measurement period. This leads to the simplification of  $di_{R,I-II}/dt \approx \gamma_l$  and thus, observing only the current derivative difference phasor is sufficient for transient leakage inductance estimation. A fault severity factor is also developed to detect stator internal faults by using the back-to-back converter’s integrated sensors along with a signal processing procedure.

**2.5 Vibration**

Investigation for WRIG stator faults detection using vibration monitoring is presented in [62–64]. Results show that stator faults have a direct impact on the torque and vibration signals because each fault has a characteristic frequency that appears in them. Thus, it can be regarded as a base for real-time condition monitoring for WRIG. Load influence on the fault-related components is examined and it shows that not all fault-related components are induced equally in the spectrum for different load levels, as some components suffer from a higher sensitivity to loading condition. The frequency components that may appear in the torque spectrum under stator fault and unbalanced supply are presented as [62]:

$$f_{ssc} = \left| \frac{n}{p}(1-s) \right| f_1 \tag{20}$$

$$f_{ssc} = \left| 2 \pm \frac{n}{p}(1-s) \right| f_1 \tag{21}$$

Reference [65] investigates the detection of stator faults using vibration signals under variable speed operation by monitoring energy changes in fault-specific frequency bands of interest. Using a time-stepped circuit model, the influence of stator electrical fault on machine operation is examined, and the simulation results show that fault-related harmonic components can be detected in the electromagnetic signal as a result of pulsating torques produced by stator asymmetric conditions. The fault-specific components are then transformed into mechanical vibration at the machine frame that can be employed for fault detection purposes using conventional vibration analysis. Numerical simulations are used to analyze the

electromagnetic torque signal under transient conditions and different fault scenarios, whereas (20) and (21) are employed to detect fault-related components in the torque signal.

The use of a fiber Bragg grating accelerometer to detect stator faults by monitoring vibration signals is presented in [66]. This shows better accuracy than other vibration monitoring systems which depend on conventional piezoelectric systems. However, fiber optic accelerometer frequency response may face difficulties in detecting the fault-related components under dynamic load conditions. It is suggested that enhancing fiber optic-based detection system data processing and design will lead to full usage of fiber optic solutions. In addition, Eqs. (20) and (21) are employed to detect fault-related components in the torque signal.

In [67], an alternative method for detecting stator faults using vibroacoustic emissions in WRIG is proposed. This provides a clearer understanding of WRIG acoustic emissions. Results also confirm that acoustic emissions are directly related to vibrational emissions which increase due to stator internal faults. A study of acoustic sensor placement is also presented to determine the effect of acoustic emission sensing distance and location on the reliability of the detection system.

**2.6 Magnetic flux**

The application of a DC bus magnetic field to detect stator faults is suggested in [68] based on the fact that most of the power flow in or out of the machine passes through the DC bus. Thus the DC bus can be used to extract valuable information about machine health, and for real-time condition monitoring. Results show that analysis of the magnetic field signal measured at the DC link of the DFIG system can provide a reliable index for the occurrence of an internal fault in the machine. The system is tested under different load conditions and different fault levels. Other types of faults inside the DFIG, which have characteristic frequencies, are also detected by tracing those frequencies in the magnetic field signal. The main disadvantage of this technique is its dependency on magnetic flux sensors which in return need more wiring and instrumentation devices. However, a Hall sensor is employed in this case. This has low cost, simple wiring, and is suitable for the complex DC bus geometry. It also demonstrates that the proposed monitoring strategy may remove the need for a classical AC phase sensor while it may provide a good condition monitoring technique for the back-to-back converter itself. Equation (16) is used to detect fault-related harmonics that may appear in the magnetic flux as a result of stator faults.

The usage of electromagnetic field analysis for the detection of stator internal faults is investigated in

**Table 1** A comparison among different techniques used to detect DFIG stator faults

References	Techniques	Advantages	Limitations
[33–35]	Park’s vector approach	Identify fault location	Affected by unbalanced voltage
[23, 39]	Multi-circuit theory	Simple	Time consuming
[41, 51, 57]	Wavelet transform	High accuracy	Time consuming
[25]	Coupled-circuit	On-line	Affected by the geometry of the machine
[44, 45]	Residual signals	Robust, low cost	Sensitive to any abnormality
[20, 24, 36, 38, 48, 55, 56]	Motor current signature analysis	High accuracy	Requires additional sensors
[41, 51, 57]	Wavelet analysis	Multi resolution	Less sensitive to low power
[52]	Magnetic equivalent circuit	High accuracy	Affected by the geometry of the machine
[43, 58, 59]	Sequence component	On-line	Unable to detect the fault location
[60, 61]	Transient leakage inductance	Identify fault severity	Affected by sensors mismatch error
[62–67]	Vibration	On-line and simple	Requires additional sensors
[68]	Dc bus field	Low cost	Requires additional sensors
[69, 70]	Magnetic flux	Identify fault location	Requires additional sensors

[69, 70]. An FEM is used to model the machine under various stator internal faults based on harmonic component analysis of the air-gap flux. The model takes into account the teeth/slots effect of stator and rotor, and the saturation of the core. The results show that the harmonic analysis of the magnetic flux is promising for the detection of stator faults. However, the main drawback of this method is that additional sensors are required for sensing the flux inside the machine. This increases the system complexity.

Figure 5 illustrates a summary of different techniques that are used to detect stator faults in DFIGs, while Table 1 represents a comparison among these techniques.

**3 Rotor faults detection methods**

Rotor faults in a DFIG contribute up to 10% of electrical faults. This can be explained by the fact that power systems that WTs are connected to often experience many disturbances such as voltage dip and voltage imbalance, which result in thermal and electrical stresses in rotor

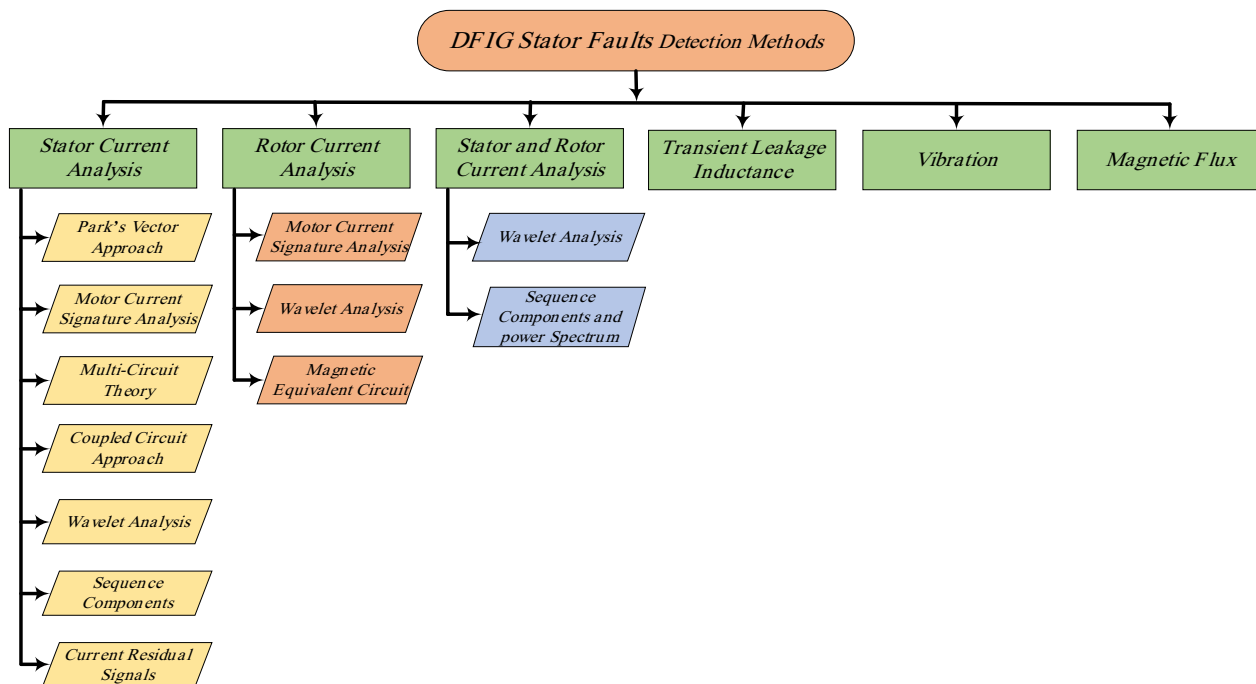

**Fig. 5** DFIGs stator faults detection methods



windings as well as mechanical stresses due to torque pulsation and vibration emission [71–73]. Also, the existence of the back-to-back converter in the rotor circuit increases the risk of rotor inter-turn short circuit faults, because of its switching action and harmonic emission. These elements have drawn the attention to the necessity of constructing a reliable condition monitoring system for the early detection of rotor faults in a DFIG. This can be summarized as follows.

### 3.1 Stator current spectrum analysis

MEC is used in [71] to drive a complete model of DFIG, which is used to investigate the impact of rotor internal faults in the stator current and control system. The work provides insight into the asymmetries between rotor internal faults and rotor with unbalanced resistance faults. It is found that the stator current is more applicable than the control signals for the detection of rotor internal faults, in contrast to the rotor with unbalanced resistance fault. This system is tested under different wind speeds and load levels (active and reactive power). The frequency components that appear in the stator current spectrum because of a rotor internal short circuit are presented as [74]:

$$f_{ind,s}^{rf} = \left| n \pm \frac{K_1}{p} (1 - s) \right| f_1 \tag{22}$$

where  $f_{ind,s}^{rf}$  is the induced frequency component in the stator current spectrum,  $k_1$  is an integer, given as  $k = 0, 1, 2, \dots$

DFIG in a WT is considered as part of a sophisticated system with a closed-loop control system. Condition monitoring systems may not be a very attractive option in this situation, as the control system continuously adapts the system parameters to control both active and reactive power and to maintain the machine in synchrony. Therefore, other signals should be investigated to acquire better indications to monitor machine conditions such as stator current which is used to detect rotor internal faults in [74–77]. In addition to stator current spectrum analysis, stator active power has also been investigated in [74] and it has shown more advantages, in respect of the amount of information that can be obtained from all phases, than the stator current spectrum. An analytical model is presented depending on (23) which represents the frequencies that can be induced in the WRIG stator because of rotor imbalance as a function of pole numbers [26].

$$f_{ind}^{\varkappa} = \left| j^* \pm \frac{\varkappa}{p} (1 - s) \right| f_1 \tag{23}$$

where  $f_{ind}^{\varkappa}$  is the induced harmonics in the stator current,  $j^*$  is the order of the grid supply induced current harmonic components ( $j^* = 1, 2, 3, \dots$ ), and  $\varkappa$  is an integer ( $\varkappa = 1, 2, 3, \dots$ ).

An algorithm for detecting broken rotor bars as well as shorted turns in induction machines is introduced in [78], based on spectrogram analysis using a fast Fourier transform (FFT). This method proves its ability to consume a smaller amount of processing time which may be considered a great advantage. Similarly, Eq. (23) is used to detect frequency components that might appear in the stator current spectrum because of the rotor internal short circuit.

The work in [79] demonstrates the use of an extended Kalman filter (EKF) to detect rotor internal faults. Performance analysis uses EKF, CWT, and an iterative localized discrete Fourier transform to determine which system has better fault tracing sensitivity. When the machine is running at low slip, EKF has better sensitivity and accuracy, while EKF also has lower computational requirements compared to CWT. In [79], Eq. (23) is used to detect fault-related components that may appear in the stator current spectrum due to rotor internal short circuits. Rotor faults are also investigated in [80] using an unscented Kalman filter (UKF) which has lower computational requirements than EKF because UKF does not have the obstacle of linearization error. The electromagnetic torque is calculated during the procedure, and is not assumed to be constant or has a definite value which represents a great advantage for this model. The proposed technique shows its ability to detect rotor faults when the system is connected to the grid or in isolated mode. As mentioned before, signal-based methods usually face a challenge in detecting machine faults during low slip operation, though this work shows high accuracy and sensitivity even near the synchronous speed.

Based on the time-synchronous averaging technique, an advanced maintenance strategy is introduced in [81, 82]. The DWT analysis of the stator current residual signals is proven efficient in the detection of rotor internal faults, and consequently, it can be implemented with condition monitor systems to construct a reliable detection system. To study rotor electrical and mechanical signals for fault measurement, a DFIG harmonic time-stepped model is presented in [83]. It is found that a rotor internal fault can lead to significant increase in the harmonic emissions in the spectra of stator current, power, speed, torque, and vibration. The magnitudes of slip-dependent fault-related harmonics show significant increases under rotor internal faults. This can be used as a reliable fault indicator.

Rotor internal faults and unbalanced rotor resistance are investigated in [84]. The proposed detection technique is constructed using the stator current, reactive power, and rotor modulating voltage, and this system is verified under several fault severities as well as different wind speeds. Discrimination between rotor internal faults and unbalanced rotor resistance is proposed based on a fault indicator extracted from tracing fault-related harmonics. The frequency components that may appear in stator reactive power spectrum and rotor modulating signals, because of rotor asymmetry, are given respectively as [71]:

$$f_{Q_s}^f = \left| i^* \pm \frac{n}{p}(1-s) \pm j \right| f_1 \tag{24}$$

$$f_{i_r}^f = -sf_1 \tag{25}$$

where  $f_{Q_s}^f$  and  $f_{i_r}^f$  are the harmonic orders induced in the stator reactive power spectrum and rotor modulating signals, respectively, because of rotor asymmetry.  $i^* = 1, 2, 3, \dots$  is an integer that refers to the supply harmonics.

Using a time-stepped model, reference [85] investigates the influence of velocity ripples and machine inertia on the emission of fault-related harmonics as a result of a rotor internal fault. Results show that DFIG rotor asymmetries increase the harmonic emission in the stator current spectrum, and this can be used as a fault detection index. The ability to detect these fault-related harmonics is severely influenced by velocity fluctuations and machine inertia. It is found that the magnitudes of these fault-related harmonics are inversely proportional to the machine inertia. However, the velocity ripples significantly change the harmonic orders of these fault-related components.

Based on the Luenberger observer, the detection of rotor asymmetries is introduced in [86, 87] to analyze the behavior of the stator residuals using a hybrid DFIG model in Matlab/Simulink. The main advantage of this observer-based method is its firmness against reference value steps. This method also has the ability to calculate the fault current (immeasurable in other methods), which can be used to calculate the thermal and magnetic effect of rotor internal faults. Results confirm that the proposed model has good sensitivity and high speed for detection.

Harmonic-based fault detection methods make use of the increase of harmonic emission that accompanies different faults, though the harmonic order may change as a result of speed variation. WTs usually operate under variable speed conditions and consequently it may be difficult to predict the harmonic order of these fault-related harmonics. To overcome this challenging issue, many methods

have been proposed to trace these fault-related harmonics. These necessitate an additional set of processing algorithms. In this regard, simplified automated fault detection for rotor electrical asymmetries is presented in [88], which uses a set of band pass filters that encompasses the ranges in which the fault-related harmonics are expected to occur in the stator current. These filters are designed to extract information to train a classifier for automatic fault detection, regardless of the specific location of the peaks. This can minimize the computational time. Results show that this technique is robust even under high-speed fluctuations and has a good accuracy against different fault levels.

### 3.2 Rotor current spectrum analysis

FS and DWT are applied to rotor modulating signals in [89, 90] to detect rotor internal faults under time and speed varying conditions, respectively. Based on the optimized use of the DWT, a simple processing technique is introduced and the results prove that rotor voltages are more sensitive than rotor currents, even when the machine is driven by a closed-loop control system where the rotor currents are continuously adapted to maintain the machine at synchronism and control active and reactive power. A dynamic time–frequency fault severity indicator is introduced to establish a preventive maintenance plan.

The use of negative-sequence components to detect rotor internal faults is proposed in [91–93]. Results show that fault severity has a significant impact on the generation of those components as well as the phase difference of the line currents. It is observed that the third and fifth harmonics are induced when the rotor suffers from an internal fault, while a negative-sequence third harmonic is noticeable when the grid is unbalanced. This can be used to distinguish the two different types of faults. FEM is introduced in [94] to detect rotor internal faults in DFIG using negative-sequence components. Based on the field circuit coupled approach, a model of the machine is constructed using ANSYS Maxwell 2D. This approach shows that as the fault severity enlarges, so does the negative-sequence rotor current. It is found that phase difference and positive- and negative-sequences of rotor current analysis may be considered as reliable fault indicators.

The use of  $dq$ -axis error signals is presented in [95] to detect rotor internal faults, which are calculated as:

$$\varepsilon i_{dr}(t) \cong - \sum_{n=1}^{\infty} I_{dr\pm 2n} \cos(2\pi(\pm 2nsf_1)t + \varnothing_{dr\pm 2n}) \tag{26}$$

$$\varepsilon i_{qr}(t) \cong - \sum_{m=1}^{\infty} I_{qr\pm 2n} \cos(2\pi(\pm 2msf_1)t + \varnothing_{qr\pm 2n}) \tag{27}$$

where  $\varepsilon i_{dr}$  and  $\varepsilon i_{qr}$  are the rotor current error signals,  $I_{dr}$  and  $I_{qr}$  are the harmonic magnitudes of the d- and q-axis rotor currents, and  $\varnothing_{dr}$  and  $\varnothing_{qr}$  are the harmonic phase shifts of the d- and q-axis rotor currents. Results show that the proposed method offers an enhanced sensitivity in comparison to stator current or total power signals.

Based on the time–frequency analysis of rotor currents, a speed sensorless method for detecting rotor internal faults in a WRIM working under non-stationary operation conditions is proposed in [96]. The mathematical formula for harmonic orders that may appear in the rotor current spectrum because of a rotor internal fault is given as:

$$f = (1 + 2k^*)sf_1 \tag{28}$$

where  $f$  is the induced harmonic order, and  $k^* = 0, \pm 1, \pm 2, \pm 3, \dots$  is an integer. In this method, the diagnostic results are always presented as a simple graph with all fault-related harmonics located exactly in the same position (the same harmonic order) regardless of the working condition (rotational speed) of the machine, which represents a great advantage for this method. Another advantage of this method is that it may be used to monitor the machine with a reduced number of parameters to improve condition monitor systems.

A space vector named hybrid fault index (HFI) is presented in [97, 98] to detect rotor internal faults using signature analysis of the space vector. The HFI is given by the product of rotor voltage and current space vectors, while the rotor current and voltage space vectors under rotor internal fault are given as:

$$\bar{i}_r(t) = I_f e^{j(s\omega t - \varnothing_{0,i})} + I_{-sf} e^{j(-s\omega t - \varnothing_{-sf,i})} \tag{29}$$

$$\bar{v}_r(t) = v_f e^{j(s\omega t - \varnothing_{0,v})} + v_{-sf} e^{j(-s\omega t - \varnothing_{-sf,v})} \tag{30}$$

where  $\bar{i}_r$  and  $\bar{v}_r$  are the rotor current and voltage space vectors, respectively.  $\omega$  is the fundamental angular frequency,  $I_f$  and  $v_f$  are the maximum value of the rotor current and voltage at angular frequency  $s\omega$ , respectively.  $I_{-sf}$  and  $v_{-sf}$  are the maximum value of the respective rotor current and voltage at angular frequency  $s\omega$ , and  $\varnothing$  is the phase shift.

The amplitude of the DC component of the HFI can be regarded as a reliable fault index, as it may be neglected under normal operation but becomes significant under rotor internal faults, under both steady-state and time-varying conditions. The main advantages of this technique are its high accuracy, robustness even under time-varying conditions, and low computational time due to no use of time–frequency signal processing techniques.

Using a Luenberger observer, a state-space observer-based condition monitoring technique for detecting rotor internal faults is presented in [99] with the aid of a reduced-order time-invariant DFIG model. The main advantage of the observer is its ability to calculate the fault current which helps to evaluate the fault severity and permits a limited operation until maintenance. Results show that the model has high accuracy and fast detection ability for different fault levels at different wind speeds.

Based on the RMS values of the wavelet coefficient and the rotor current, another method for detecting rotor faults is proposed in [100] that calculates the fault severity using spectral analysis. Results show that the proposed processing algorithm is convenient for detecting rotor faults and calculating the fault severity. Also, the proposed technique has good accuracy in detecting rotor faults under different loading conditions as well as different fault scenarios.

Reference [101] proposes a detection technique that combines a condition monitoring system and particle swarm optimization based on rotor current analysis. The technique has the advantage of a lower computational time than other techniques. Results show that the proposed technique can detect rotor faults effectively and robustly even under different rotational speeds. Also, the technique has high reliability and can reduce error signals. This can thus be used for precise maintenance planning.

### 3.3 Stator and rotor current spectrum analysis

Reference [102] proposes the use of five different fault measures from stator and rotor currents to detect rotor faults. The first can be verified by measuring the amplitudes of stator current fault-related harmonics which can be calculated as [103]:

$$f_{jam1} = f_1(1 \pm 2.n.s) \tag{31}$$

The second piece of fault evidence can be verified by measuring the amplitudes of fault-related harmonics amplified by the rotor fault. These harmonics can be used to distinguish rotor damage and other effects, such as the presence of load oscillations since they are less affected by pulsations in the driven load torque. The mathematical formulae used to calculate the second family harmonics are given as [103]:

$$f_{jam21} = f_1[(6n - 1) - 6ns] \tag{32}$$

$$f_{jam22} = f_1[(6n - 1) - (6n - 2)s] \tag{33}$$

The third piece of evidence can be provided by analyzing the startup current detection of the V-shaped pattern

caused by the fault-related harmonics in the time–frequency domain [104]. The fourth piece of evidence is a fault severity factor based on the DWT of the startup current. This relates the total energy of the startup current to the signal processed by the DWT. The result proves that a certain level of the fault severity factor is a good indicator for a rotor internal fault. The fifth indicator depends on tracing fault-related harmonics at  $-sf_1$  in the rotor current space vector spectrum. The main advantage of this algorithm is the detection of rotor internal faults at different fault levels and operational conditions with high accuracy and without any false trip.

### 3.4 Power spectrum analysis

Based on CWT and power and speed signals, a condition monitoring technique to detect rotor internal faults in a DFIG is presented in [105]. The continuous wavelet transform for the power real-time signal is given as:

$$CWT_{(b,a)} = \frac{1}{\sqrt{|a|}} \int_{-\infty}^{\infty} P(t) \varphi^* \left( \frac{t-b}{a} \right) dt \quad (34)$$

where  $a$  is the wavelet scale,  $b$  is the wavelet time-shift parameter,  $P(t)$  is the power real-time signal, and  $\varphi^*$  is the conjugate of the mother wavelet function.

In this method, a band pass filter is implemented with its central frequency being controlled by the wind speed, and the filter bandwidth is accommodated to the speed fluctuation. Results show that it has low memory burden and low detection time. Its main disadvantage is that it cannot detect small faults, although their effect on the processed signal is still noticed. This can be explained by the fact that there are residual imbalances present in the auxiliary components in the rotor circuit, and the time varying rotational speed hides the fault-related components, making them difficult to trace. Reference [106] discusses the effect of the control system on power signal-based rotor internal fault detection systems. Results show that the control system has a significant impact on rotor current signature analysis that must be taken into consideration during system tuning or pre-setting.

### 3.5 Magnetic flux

The impact of rotor internal faults on the magnetic circuit of a DFIG is presented in [107] based on coupled electromagnetic and thermal field analyses. FEM is used to analyze the characteristics of a magnetic field, temperature distribution, and heat transfer during healthy and faulty operations. Results show that some harmonic components are more affected by the fault than others. Its main advantage is that it focuses on the thermal effect of the rotor internal fault and the hotspots combining it, which can be used to improve the thermal design and heat transfer in DFIG.

A FEM of DFIG is presented in [108] and is used to study the effect of rotor internal faults on the magnetic circuit. The phase angle difference, the harmonic content of rotor currents, and the harmonic content of magnetic flux are also investigated. Results show that, as the fault severity grows, the air-gap magnetic flux becomes asymmetrical with a significant increase in both fractional and even fault-related harmonic components. The phase angle and amplitude of the rotor currents change significantly with increase in the induced third harmonic component. This technique has good accuracy under different fault severities, although it has not been tested under variable speed operation.

### 3.6 Vibration

Based on the analysis of torque and vibration signals of WRIG, a numerical model is presented in [109] to study the influence of rotor internal faults on machine behavior. Results prove that the main effect of rotor internal faults is reflected as twice slip frequency ( $2sf$ ) in the torque signal. In addition, the fault-related harmonics that have been induced in the torque signal can also be traced in the vibration signal. This method is tested under different rotational speeds with different fault scenarios and shows good detection accuracy. A radial basis function neural network (RBFNN) is used to detect rotor internal faults in [110] based on analyzing the magnetic circuit and rotor vibration characteristic, and is examined under different fault levels. Its main advantage is the high detection speed which reduces the computational time, while it is also independent of the machine parameters, which means less time is required during initialization and setup. Results show that during rotor internal faults, the exciting current and rotor vibration increase, while at the same time the reactive power is decreased.

Figure 6 illustrates a summary of different techniques that are used to detect rotor faults in a DFIG, while Table 2 represents a comparison among these different techniques.

## 4 Common detection methods

In this section, the common methods that can be used for the detection of both stator and rotor internal faults are reviewed. These techniques depend on tracing the fault related harmonics that may appear in the spectrum of different parameters in a DFIG. The main advantage of these detection algorithms is the extended protection zone including both the stator and the rotor at the same time. However, this may increase the computational burden and time especially when taking into consideration the effect of wind speed variation and a closed-loop control system.

**Table 2** A comparison among different techniques used to detect DFIG rotor faults

References	Techniques	Advantages	Limitations
[71]	Magnetic equivalent circuit	High accuracy	Affected by the geometry of the machine
[76–79, 84, 88, 95, 97, 98]	Fourier analysis	High accuracy	Affected by the change of speed and torque
[81, 82, 89, 90, 96, 100, 102]	Wavelet analysis	High accuracy	Time consuming
[74, 75, 85]	Coupled-circuit	On-line	Affected by the geometry of the machine
[86, 87, 99]	Luenberger observer	Reduced computation time	Sensitive to any abnormality
[91–93]	Sequence component	On-line	Unable to detect the fault location
[101]	Support vector machine	Robust	Require expert opinion
[105, 106]	Power spectrum	Discriminate load oscillation	Applicable to low-frequency oscillation
[94, 107, 108]	Magnetic flux	Identify fault location	Requires additional sensors
[109, 110]	Vibration	On-line and simple	Requires additional sensors

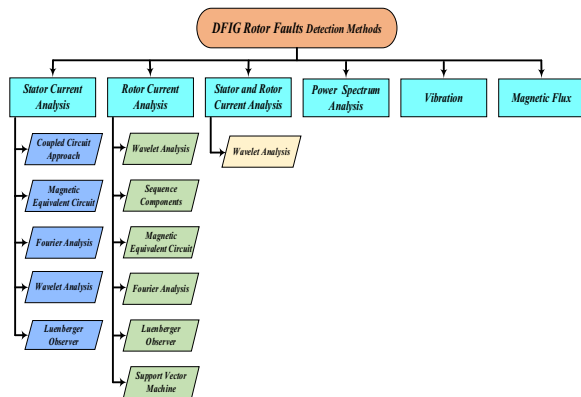

**Fig. 6** DFIGs rotor faults detection methods

**4.1 Stator current spectrum analysis**

Reference [26] proposes the use of stator currents to detect both stator and rotor internal faults in a DFIG. A time-stepped coupled-circuit model for the machine is presented to simulate the harmonics that may appear in the stator currents because of stator or rotor faults. Results show that the design of parts of the machine such as of the coil pitch and rotor skew have great effect on the magnitudes of these harmonic components. However, these results have not been tested under different speeds or fault levels. The mathematical expressions in (3) and (22) are employed to calculate the orders of harmonics that may appear in the stator current as a result of stator or rotor faults.

Stator reactive power is used in [111, 112] for detecting stator and rotor faults based on FFT. Results prove that both stator and rotor faults can be detected by tracing fault-related components located at twice the supply frequency ( $2f_1$ ) and twice the slip frequency ( $2sf_1$ ). The stator reactive power under stator and rotor internal faults can be presented as:

$$Q_s = \underbrace{\frac{3}{2}v_{qs}i_{ds}^+}_{dc \text{ component}} + \underbrace{\frac{3}{2}v_{qs}(i_{ds}^{usb} + i_{ds}^{lsb})}_{frequency \text{ of } 2f_s} = Q_{s\{dc\}} + \Delta Q_{s\{|2f_1\}} \quad (35)$$

where  $Q_s$  is the stator reactive power,  $Q_{s\{dc\}}$  and  $\Delta Q_{s\{|2f_1\}}$  are the dc component and amplitude of the oscillating component at the frequency of  $|2f_1|$  in the stator reactive power, respectively.  $v_{qs}$  is the stator voltage component in q-axis, and  $i_{ds}^+$  is the d-axis positive-sequence component of the stator current.  $i_{ds}^{usb}$  and  $i_{ds}^{lsb}$  are the components of the stator current in d-axis at the frequencies of  $2f_1$  and  $-2f_1$ , respectively.

In the study, severity factors are defined for both types of faults and are examined to check their reliability under several load conditions and wind speed. Harmonic-based detection methods suffer from a low detection ability when the machine is running at low slip, and thus the fault may remain undetected until the slip is changed. The severity factor for both stator and rotor faults are given as:

$$SF_{sf}(\%) = \frac{\Delta Q_{s\{2f_1\}}}{Q_{sn}} \times 100\% \quad (36)$$

$$SF_{rf}(\%) = \frac{\Delta Q_{s\{|2f_1\}}}{|s| \times Q_{sn}} \times 100\% \quad (37)$$

where  $SF_{sf}$  and  $SF_{rf}$  are the severity factors under stator and rotor internal faults, respectively, and  $Q_{sn}$  is the rated stator reactive power of the DFIG.

Based on instantaneous frequency (IF) extraction of the fault-related components in stator and rotor currents during speed fluctuation, an internal fault detection technique is presented in [113]. The proposed technique depends on tracing the increase in the fault-related components and the characteristic patterns of the IF. Under

nonstationary conditions, the graphs of the IF of the fault-related components in the slip-frequency domain are straight lines. Additionally, the slope and  $y$ -interception of these lines are unique for each type of fault and independent from the machine design, the amount of load, or speed variation. Therefore, the IF graphics are considered to be a reliable index for the detection and classification of the faults. Consequently, this approach has a very low risk of producing false detection.

Reference [114] proposes a detection methodology that employs probabilistic intelligence technique Bayesian classification together with stator voltage signature analysis using WRIG FEM. Generator behavior is examined under normal and abnormal conditions such as stator and rotor internal faults. Results indicate that if the Bayes classifier has been accurately tuned, it has high accuracy and can be used to enhance preventive maintenance strategies for the WRIG.

#### 4.2 Rotor current spectrum analysis

Rotor modulating signals spectrum analysis is introduced in [115, 116] to detect both stator and rotor internal faults in a DFIG. Results prove that the rotor modulating signals have harmonic content that could be regarded as a reliable index for stator and rotor internal faults, in comparison to rotor and stator current. The harmonic frequencies that are expected to appear in the rotor modulating signals because of stator and rotor internal faults are given as:

$$f_{sa} = (2 - s)f_1 \tag{38}$$

$$f_{ra} = -sf_1 \tag{39}$$

where  $f_{sa}$  and  $f_{ra}$  are the harmonic frequencies related to stator and rotor internal faults, respectively.

The influence of the closed-loop control system must be taken into consideration when the detection of asymmetries in DFIG is based on the signature analysis of electrical variables. The investigation presented in [117] discusses the behavior of fault-related components against different bandwidths of closed-loop regulators to determine the effectiveness of any detection system that may use those variables while the machine is being driven by a closed-loop control system. Also, a detection method is presented to detect stator and rotor internal faults through the signature analysis of pulse width modulated rotor voltages. The proposed approach proves its efficiency under variations of the current loop bandwidth. Equations (38) and (39) are employed to calculate the harmonic frequencies that are expected to appear in the rotor modulating signals because of stator and rotor

internal faults, respectively. However, this method has not been tested under different speed or fault levels.

Loci of  $d$ - and  $q$ -axis rotor currents are presented in [30] for the detection of stator and rotor faults in a WRIG. Its main advantage is the ability to discriminate among the stator and rotor internal faults, and unbalanced supply voltage. Under healthy conditions, the direct and quadrature current vectors have the same amplitude. Consequently, the vector summation of the components has a circular shape regardless of load condition. However, during a rotor fault, the rotor currents become unbalanced and the resultant vector summation becomes elliptical in shape. On the other hand, during stator faults, higher-order harmonics are generated in rotor circuit making vector summation of rotor current components a leaf-shape structure. The number of leaf-shaped structures is mathematically expressed as:

$$N_l = D_h + 1 \tag{40}$$

where  $N_l$  is number of leaf-shaped structure and  $D_h$  is the order of the dominant harmonic component.

The size of a leaf-shaped structure is directly proportional to space harmonic index and can be mathematically expressed as:

$$HI = \frac{A_D}{A_f} \tag{41}$$

where  $HI$  is the harmonic index,  $A_D$  is the amplitude of dominant harmonic in the rotor current, and  $A_f$  is the amplitude of the fundamental component in the rotor current.

A fault detection method based on a sliding mode observer is proposed in [118], where a mathematical model for this sliding mode observer is employed with a state-space model of a DFIG. Results shows that the technique has good stability and fast detection speed. This method has also been verified under different wind speed and fault levels.

#### 4.3 Stator and rotor current spectrum analysis

References [119, 120] propose a detection technique based on signature analysis of both stator and rotor currents to detect internal faults in a DFIG. This technique has been tested under different fault degrees, but not under different wind speed. The mathematical expressions in (3) and (22) are employed to calculate the order of harmonics that may appear in the stator current spectrum because of stator or rotor internal faults.

In [121], the behavior of a WRIG under both stator and rotor internal faults is investigated. Simulations using  $qd$  model in a stationary reference frame in MATLAB/Simulink are carried out to investigate the behavior of

different parameters in the machine such as electromagnetic torque, rotor speed, and stator and rotor currents under asymmetrical operation. It shows that under internal faults, the time and size of ripples in torque and rotor speed signals are changed and additional fluctuations in steady-state are also detected. Moreover, during the winding fault, the harmonic components change significantly in both the stator and rotor currents in steady-state and transient. The total harmonic distortions (THD) are measured for both rotor and stator currents under faulty and healthy operation. Results show that in the case of stator and/or rotor internal faults, rotor currents have higher THD compared to that of stator currents. This can be explained by the fact that the rotor is already connected to a back-to-back converter which increases the harmonic emission because of its high-speed switching nature. Results demonstrate that during rotor internal faults, the calculated THD is always higher than the stator internal fault condition.

A WRIG is simulated in [122] under both stator and rotor internal faults using the complete MEC model. The differences between rotor and stator internal faults such as the amplitude of the fault current, the effect of fault severity load level on the fault current, and phase difference between the fault current and stator and rotor currents are presented. The main advantage of the proposed model is that it takes into consideration some elements from the magnetic circuit such as stator and rotor teeth local saturation, rotor slot skewing, the effect of stator and rotor teeth, and space harmonics in the stator and rotor circuit on the behavior of the detection system.

An internal fault detection technique based on stator electrical signals (voltage and current) and rotor currents is investigated in [123]. An FEM of the machine is presented under healthy and unhealthy operational conditions and different fault degrees to produce an initial design and test procedure for the detection system. The results indicate that the stator signals and rotor current demonstrate a reliable index for detecting the investigated faults. It is found that the detection system has good detectability due to the large amount of information extracted by the combination of these signals.

#### 4.4 Magnetic flux

External leakage flux sensor is used in [124] to detect both stator and rotor internal faults in WRIGs instead of using the common technique of MCSA. The technique is simple as the physical connection between the machine and the flux sensor is not required. The harmonic frequencies that appear in the flux spectrum because of rotor and stator internal faults are presented as:

$$f_{rotor} = (1 \pm 2s)f_1 \tag{42}$$

$$f_{stator} = \left[ \gamma \frac{N_r}{p} (1 - s) \pm \xi \right] f_1 \tag{43}$$

where  $f_{rotor}$  and  $f_{stator}$  are the flux induced harmonics due to rotor and stator internal faults, respectively.  $\gamma = 0, 1, 2, 3, \dots$  is an integer,  $N_r$  is the number of rotor slots, and  $\xi = 0, 1, 2, \dots$  is also an integer.

#### 4.5 Artificial neural networks (ANN)

An ANN with digital inputs is used in [125] to detect and localize internal faults in a DFIG. This method is based on the back-propagation algorithm which makes its architecture uncomplicated while also not requiring large computational time. Because of its efficiency and simplicity, it can be used in industrial development with basic hardware to decrease the cost of modern condition monitoring systems adapted to wind farms.

Reference [123] investigates the use of artificial intelligence to detect both rotor and stator faults in WRIGs. It is found that the normalized frequency-based magnitudes of several harmonics of the stator voltage and current, and rotor current exhibit patterned variations when the machine is subjected to an internal fault. It proposes to use machine learning algorithms to enhance the accuracy of the detection system. The work presented in [126] suggests combinations of condition monitoring techniques and a machine-learning algorithm to detect both rotor and stator faults in WRIGs. The work aims to develop an unsupervised learning algorithm as a means of recognizing fault related patterns which in return will reduce the computational burden and increase system accuracy even with small faults. A high-dimensional K-means modelling approach is used to develop diagnostic models for the machine under different incipient fault conditions. The findings from this model indicate that stator current harmonics provide the best results among the single-signature harmonics feature sets, while the combined set of harmonics from all signatures yield excellent model structures when measured against the ground truth.

Figure 7 illustrates a summary of different techniques that are used to detect stator and rotor faults in a DFIG, while Table 3 presents comparisons for these different techniques.

#### 5 Real application

There are many monitoring systems available in the market that can be used to detect the internal faults of DFIG-based WT's. The Dynapar Onsite condition monitoring

**Table 3** A comparison among different techniques used to detect DFIG both rotor and stator faults

References	Techniques	Advantages	Limitations
[30, 111, 112, 115–117, 119–121]	Fourier analysis	High accuracy	Affected by the change of speed and torque
[26]	Coupled-circuit	On-line	Affected by the geometry of the machine
[113]	Wavelet analysis	High accuracy	Time-consuming
[114, 123]	Finite element	High accuracy	Affected by the geometry of the machine
[122]	Magnetic equivalent circuit	High accuracy	Affected by the geometry of the machine
[124]	Magnetic flux	Identify fault location	Requires additional sensors
[123, 125, 126]	Artificial neural networks	Simple and fast	Requires Additional sensors

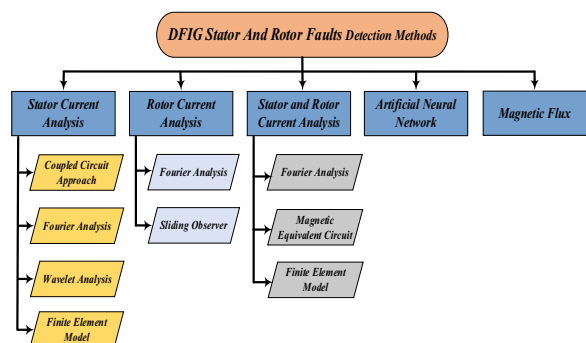

**Fig. 7** DFIGs internal faults common detection methods

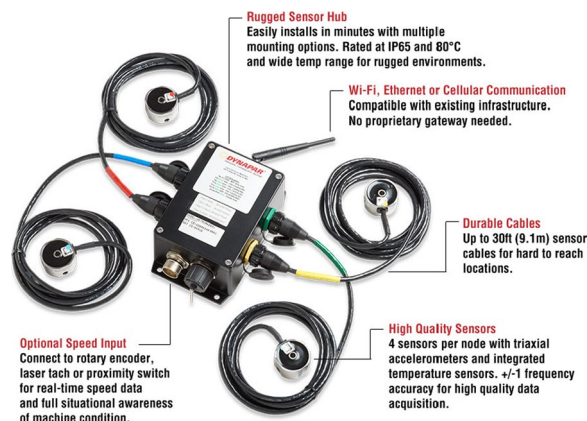
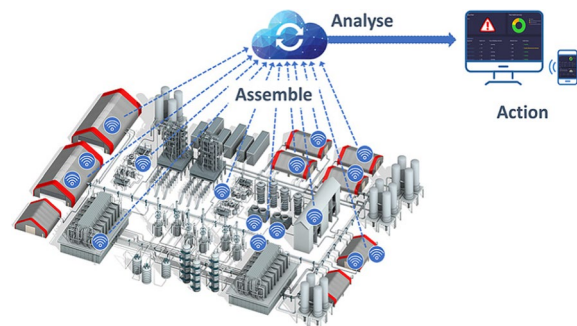

**Fig. 8** Dynapar onsite condition monitoring system

system is one of the available products which is equipped with vibration, temperature, and speed sensors as shown in Fig. 8. The system is also equipped with a computer-based analysis tool that interprets the readings obtained from different sensors and presents them in a simple graph. This system is capable of detecting several mechanical problems such as eccentricity and bearing issues.

Figure 9 shows the Miniotec’s compact wireless vibration monitor technology. This solution comprises three main components, i.e., wireless sensor, cloud computing, and machine learning algorithm. The system does not require any hardwiring between the sensors and the main system as the signals are transmitted using Wi-Fi connectivity. However, all the sensors in the system are powered by a battery which must be periodically replaced, while the usage of Wi-Fi connectivity also leads to a potential cyber-security problem. The system is capable of detecting several electrical and mechanical faults such as unbalanced misalignment, bearing faults, looseness, and cavitation as well as electrical faults such as rotor bar faults and winding faults.

The Baker EXP4000 dynamic motor analyzer is another product in the market for rotating equipment condition monitoring using MCSA. By monitoring many different parameters and using advanced software algorithms, it



**Fig. 9** Miniotec’s compact wireless vibration monitor system

provides a highly accurate root-cause analysis, starting with the separation of mechanical and electrical issues that may be present in the machine system. The system can detect a wide range of problems such as broken rotor bars, transient overloading, and mechanical imbalances along with bearing and cavitation problems.

The Artesis machine condition monitoring (MCM) and predictive maintenance condition monitoring system can be used to detect several mechanical and electrical faults such as loose foundation, mechanical imbalance,



misalignment, gearbox faults, bearing faults, stator, and rotor internal electrical faults, and external electrical faults. It is also equipped with software that performs a high-speed analysis with clear information for fault detection, diagnostics, time to failure, and corrective actions.

The Samotics SAM4 can be used to detect many electrical and mechanical faults inside induction machines such as stator inter-turn fault, stator winding looseness, electrical imbalance, broken/loose rotor bars, rotor eccentricities, misalignment, bearing degradation, and mechanical imbalance. Similar to the Artesis MCM, it also comes with software that provides continuous real-time information on the health, performance, and energy consumption of the machine.

## 6 Challenges and future trends

Although there are many techniques that can be used to detect internal electrical faults in DFIG-based WTs, there are several challenges and future trends, summarized as follows:

- Most of the fault detection approaches assume that the measuring instruments or sensors (current, voltage, power, etc.) work in ideal operation modes. However, they may be subjected to saturation due to the rapid increase in fault current in a DFIG, while measuring instrument error or mismatch may also cause severe problems as it may fail to accurately represent the required waveforms. The detection system may malfunction in terms of the accuracy of fault identification and detection time. Therefore, it is recommended that further investigations should be carried out to study the quality and cost of the sensors and establish an algorithm to overcome this issue.
- Accurate identification of a specific fault type and its location is very challenging in a DFIG as the control system continuously adapts the machine parameters as a result of wind speed variation to keep the machine in synchrony. In addition, the load level, grid parameters, temperature influence, and even machine geometry are important parameters that affect the accuracy of fault identification. Current fault detection systems mainly rely on analyzing the response of the DFIG, i.e., establishing a reliable fault-related pattern that may be used as a fault index. As the occurrence of one fault inside the machine may be combined with other faults, it becomes even more challenging to detect all the faults. Also, the existence of the back-to-back converter in the rotor circuit and its induced harmonics due to its switching need further investigation. Therefore, more research should be conducted to investigate the behavior of the existing internal fault detection techniques when they are subjected to several faults at the same time. It is also recommended to take into consideration the effect of the control system, the load nature, grid parameters, and the effect of the back-to-back converter.
- There are insufficient in-depth studies on the precise identification of internal faults threshold in a DFIG. In a model-based fault diagnostic procedure or a real-time condition monitoring system, the threshold plays an important role. The fault threshold is closely linked to the fault diagnostic capability of the fault detection technique, and the setting of the threshold has not been investigated or addressed in current research. Determining the threshold is a trade-off between the ability to detect small faults and false alarming. Furthermore, the aging of a DFIG will impact the accuracy of the threshold. Thus, more research should be conducted to study the modification of threshold against DFIG age taking into consideration different machine parameters such as rated power, operational voltage, losses, and machine cooling system.
- As most of the turn-to-turn faults inside any machine are the result of severe thermal stress on the machine windings that has led to insulation degradation, it is very important to establish an accurate thermal management system for DFIG units. This system should guarantee that the operating temperature of the unit remains within a certain range where the DFIG can produce a suitable performance without causing any damage to the WT. However, there has been little research on the thermal management strategy that can be employed in real DFIG-based WT systems. Thus, more research should be conducted to investigate the optimization of a DFIG cooling system.
- It is recommended to enhance the accuracy of fault severity calculation techniques, construct the internal electrical fault ride-through capability algorithm, and study the internal faults in brushless DFIG.
- More research should be done focusing on the application of artificial intelligence techniques such as ANN. These new techniques can increase the reliability of the detection methods and reduce computational burden. Also, data science is one of the most essential tools for estimating the occurrence of different internal DFIG faults. Moreover, using the Internet of Things (IoT), cloud platforms, and Fog, system monitoring is improved, data and information storage is enhanced, and reasonable decision-making time is ensured. It is also necessary to study the cyber security of modern communication systems.

## 7 Conclusion

In this paper, the detection and diagnosis methods of internal faults in DFIG-based WTs have been reviewed. Finding a reliable DFIG online condition monitoring system has become a very important research topic for over a decade. The main requirements are high detection accuracy, early detection of the fault, and low computational requirement. A reliable detection system will allow the operator to build and create an accurate maintenance plan resulting in cost reduction. The internal fault detection techniques of DFIG-based WTs can be summarized as follows:

- *Stator current-based methods*: They are robust and low-cost, and their main limitation is the high sensitivity to any abnormalities that may occur in the system.
- *Rotor current-based methods*: they are robust methods with no need for any external sensors as the built-in sensors in the back-to-back converter can be used for this purpose. However, these methods are very sensitive to speed fluctuations.
- *Wavelet analysis-based methods*: the methods have a multi-resolution detection scope. Their main drawback is that they are not sensitive to minor faults.
- *Magnetic equivalent circuit-based methods*: the methods provide high accuracy for fault detection, though they are easily affected by machine parameters such as geometry, and number of poles.
- *Fourier analysis-based methods*: these methods provide fast detection. The main drawback is how they are affected by speed fluctuations.
- *MCSA based methods*: these methods provide high accuracy. However, they can be easily affected by a change in torque or speed.
- *Vibration-based methods*: their main advantage is simplicity as they do not require complicated mathematical models or algorithms, while their main disadvantage is the requirement for additional sensors to be connected to the machine which makes the system more expensive and complicated. The sensor mismatch could also affect the reliability of the system leading to a false trip.
- *Flux-based methods*: The main advantage of these methods is their high accuracy, while the main disadvantage is that additional sensors are also required which affect the reliability and cost of the operational system, and increase the complexity of the system. These methods also require a considerable amount of information to be fed to the detection algorithm which in return represents a high computational burden to the system.

These methods have been discussed in detail and compared with each other in this paper. Each technology has advantages and disadvantages, and operators need to choose a suitable method based on the operating conditions and the surrounding environment. Some of the real monitoring systems available in the market are also presented. Finally, the challenges and future trends facing the techniques are discussed. This work is organized in a tutorial manner, to be an effective guide for future research, and to play a role in enhancing the stability and reliability of DFIG-based WTs.

### Abbreviations

ANN: Artificial neural networks; CWT: Continuous wavelet transform; DFIGs: Doubly-fed induction generators; DWT: Discrete wavelet transform; EKF: Extended Kalman filter; EPVA: Extended Park's vector approach; FDI: Fault Diagnostic Index; FEM: Finite element model; FFT: Fast Fourier transform; FS: Frequency sliding; HFI: Hybrid Fault Index; IF: Instantaneous frequency; IoT: Internet of Things; ITSCF: Inter-turn short circuit fault; LKF: Linear Kalman filter; LPV: Linear parameter varying; MCM: Machine condition monitoring; MCSA: Machine current signatures analysis; MEC: Magnetic equivalent circuit; RBFNN: Radial basis function neural network; THD: Total harmonic distortion; UKF: Unscented Kalman filter; WRIG: Wound rotor induction generator; WTs: Wind turbines.

### Acknowledgements

The authors are grateful to Faculty of Engineering, Mansoura University, El-Mansoura, Egypt for providing necessary facilities to carry out the work.

### Author contributions

AB: data curation, resources, writing- original draft preparation; AE: conceptualization, methodology, validation; GA: visualization, investigation; EB: review and editing the manuscript. All authors read and approved the final manuscript.

### Funding

Not applicable.

### Availability of data and materials

Not applicable.

### Declarations

### Competing interests

The authors declare that they have no known competing financial interests or personal relationships that could have appeared to influence the work reported in this paper.

Received: 28 November 2021 Accepted: 24 March 2022

Published online: 03 May 2022

### References

1. Enevoldsen, P., & Xydi, G. (2019). Examining the trends of 35 years growth of key wind turbine components. *Energy for Sustainable Development*, 50, 18–26.
2. Muniappan, M. (2021). A comprehensive review of DC fault protection methods in HVDC transmission systems. *Protection and Control of Modern Power Systems*, 6(1), 2021.
3. Faiz, J., & Moosavi, S. (2015). Review of eccentricity fault detection techniques in IMs focusing on DFIG. In *5th IEEE international conference on power engineering, energy and electrical drives* (pp. 513–520), Riga, Latvia.

4. Amirat, Y., Choqueuse, V., & Benbouzid, M. (2009). A brief status on condition monitoring and fault diagnosis in wind energy conversion system. *Renewable and Sustainable Energy Reviews*, 13, 2629–2636.
5. Nandi, S., & Toliyat, H. (2005). Condition monitoring and fault diagnosis of electrical machines—A review. *IEEE Transactions on Energy Conversion*, 20(4), 719–729.
6. Kliman, G., & Stein, J. (1992). Methods of motor current signature analysis. *Electric Machines and Power Systems*, 20(5), 463–474.
7. Nadour, M., Essadki, A., & Nasser, T. (2020). Improving low-voltage ride-through capability of a multimegawatt DFIG based wind turbine under grid faults. *Protection and Control of Modern Power Systems*, 5, 1.
8. Benbouzid, M., Vieira, M., & Theys, C. (1999). Induction motor fault detection and localization using stator current, advanced signal processing techniques. *IEEE Transactions on Power Electronics*, 14(1), 14–22.
9. Mensou, S., Essadki, A., Nasser, T., & Idrissi, B. (2020). A direct power control of a DFIG based-WECs during symmetrical voltage dips. *Protection and Control of Modern Power Systems*, 5, 1.
10. Sheta, A., Abdulsalam, G., & Eladl, A. (2021). Online tracking of fault location in distribution systems based on PMUs data and iterative support detection. *Electrical Power and Energy Systems*, 128, 106793.
11. Rienstra, A., & Hall, J. (2004). *Applying acoustic vibration monitoring to predictive maintenance*. <http://www.maintenanceworld.com/Articles/Rienstra/ultrasonic.pdf>.
12. Aylard, A., Meyer, A., & Landy, C. (1995). Acoustic evaluation of faults in electrical machines. In *7th International conference on electrical machines and drives* (pp. 147–150), Durham, UK.
13. Wang, C., & Gao, R. X. (2000). Sensor placement strategy for in-situ bearing defect detection. In *17th IEEE instrumentation and measurement technology conference* (Vol. 3, pp. 1463–1467), Baltimore, MD, USA.
14. Cameron, J., Thomson, W., & Dow, A. (1986). Vibration and current monitoring for detecting airgap eccentricity in large induction motors. *IEE Proceedings B-Electric Power Applications*, 133(3), 155–163.
15. Trutt, F., Sottile, J., & Kohler, J. L. (2002). Condition monitoring of induction motor stator windings using electrically excited vibrations. In *IEEE industry applications conference. 37th IAS annual meeting* (Vol. 4, pp. 2301–2305), Pittsburgh, PA, USA.
16. Eonard, R., & Thomson, W. (1986). Vibration and stray flux monitoring for unbalanced supply and inter-turn winding fault diagnosis in induction motors. *British Journal of Non-Destructive Testing*, 28(4), 211–215.
17. Tavner, P. (2008). Review of condition monitoring of rotating electrical machines. *IET Electric Power Application*, 2(4), 215–247.
18. Jeffries, W., Chambers, J., & Infield, D. (1998). Experience with bicoherence of electrical power for condition monitoring of wind turbine blades. *IEE Proceedings Vision, Image and Signal Processing*, 145(3), 141–148.
19. Popa, L., Jensen, B., Ritchie, E., & Boldea, I. (2003). Condition monitoring of wind generators. In *38th IAS annual meeting on conference record of the industry applications conference* (Vol. 3, pp. 1839–1846), Salt Lake City, UT, USA.
20. Douglas, H., Pillay, P., & Barendse, P. (2005). The detection of interturn stator faults in doubly-fed induction generators. In *Fortieth IAS annual meeting. conference record of the 2005 industry applications conference* (Vol. 2, pp. 1097–1102), Kowloon, Hong Kong.
21. Stefani, A., Yazidi, A., Rossi, C., Fillipeti, F., Casadei, D., & Capolino, G. A. (2008). Doubly fed induction machines diagnosis based on signature analysis of rotor modulating signals. *IEEE Transaction Industrial Application*, 44(6), 1711.
22. Wang, P., Song, J., Liang, F., et al. (2021). Equivalent model of multi-type distributed generators under faults with fast-iterative calculation method based on improved PSO algorithm. *Protection and Control of Modern Power Systems*, 6(29), 1.
23. Lu, Q., Cao, Z., & Ritchie, E. (2004). Model of stator inter-turn short circuit fault in doubly-fed induction generators for wind turbine. In *35th Annual IEEE power electronics specialists conference* (Vol. 2, pp. 932–937), Aachen, Germany.
24. Shah, D., Nandi, S., & Neti, P. (2009). Stator inter-turn fault detection of doubly fed induction generators using rotor current and search coil voltage signature analysis. *IEEE Transaction Industrial Application*, 45(5), 1831–1842.
25. Djurovic, S., Williamson, S., & Renfrew, A. (2009). Dynamic model for doubly fed induction generators with unbalanced excitation, both with and without faults. *IET Electric Power Application*, 3(3), 171–177.
26. Williamson, S., & Djurovic, S. (2009). Origins of stator current spectra in DFIGs with winding faults and excitation asymmetries. In *IEEE international electric machines and drives conference* (pp. 563–570), Miami, FL, USA.
27. Crabtree, C., Djurovic, S., Tavner, P., & Smith, A. (2010). Condition monitoring of a wind turbine DFIG by current or power analysis. In *5th IET international conference on power electronics machines and drives* (pp. 1–6), Brighton, UK.
28. Crabtree, C., Djurovic, S., Tavner, P., & Smith, A. (2010). Fault frequency tracking during transient operation of wind turbine generators. In *The XIX international conference on electrical machines* (pp. 1–5), Rome, Italy.
29. Yazidi, A., Henao, H., Capolino, G., & Betin, F. (2010). Rotor inter-turn short circuit fault detection in wound rotor induction machines. In *The XIX international conference on electrical machines* (pp. 1–6), Rome, Italy.
30. Vilhekar, T., Ballal, M., & Suryawanshi, H. (2017). Detection of winding faults in wound rotor induction motor using loci of direct and quadrature axes of rotor currents. *Electric Power Components and Systems*, 45(11), 1217–1230.
31. Balasubramanian, A., & Muthu, R. (2017). Model based fault detection and diagnosis of doubly fed induction generators: A review. *Energy Procedia*, 117, 935–942.
32. Hamatwi, E., & Barendse, P. (2020). Condition monitoring and fault diagnosis of stator and rotor interturn winding faults in a DFIG-based wind turbine system: A Review. In *International SAUPEC/RobMech/PRASA conference* (pp. 1–6), Cape Town, South Africa.
33. Cruz, S., & Marques Cardoso, A. (2001). Stator winding fault diagnosis in three-phase synchronous and asynchronous motors, by the Extended Park's Vector Approach. *IEEE Transactions on Industry Applications*, 37(5), 1227.
34. Bilal, H., Heraud, N., & Sambatra, E. (2020). Detection of inter-turn short-circuit on a doubly fed induction machine with D-Q axis representation. In *61st IEEE international scientific conference on power and electrical engineering*, Riga Technical University (RTU/CON), Riga, Latvia.
35. Chen, Y. et al. (2015). FEM simulation and analysis on stator winding inter-turn fault in DFIG. In *11th IEEE international conference on the properties and applications of dielectric materials (ICPADM)* (pp. 244–247), Sydney, NSW, Australia.
36. Albizu, I., Tapia, A., Saenz, J. R., Mazon, A. J., & Zamora, I. (2004). On-line stator winding fault diagnosis in induction generators for renewable generation. In *12th IEEE mediterranean electrotechnical conference* (Vol. 3, pp. 1017–1020), Dubrovnik, Croatia.
37. Benbouzid, M. (2000). A review of induction motors signature analysis as a medium for faults detection. *IEEE Transactions on Industrial Electronics*, 47(5), 984–993.
38. Hameed, Z., Hong, Y., Cho, Y., Ahn, S., & Song, C. (2009). Condition monitoring and fault detection of wind turbines and related algorithms: A review. *Renewable and Sustainable Energy Reviews*, 13(1), 1–39.
39. Jun-qing, L., De-yan, W., & Li, M. (2011). The research of the inter-turn short circuit of the stator windings in doubly fed induction generator. In *International conference on electrical machines and systems* (pp. 1–4), Beijing, China.
40. Williamson, S. (1983). Power factor improvement in cage rotor induction motor. *IEE Proceedings*, 130, 121–129.
41. Kia, M., Khedri, M., Naja, H., & Nejad, M. (2013). Hybrid modelling of doubly fed induction generators with inter-turn stator fault and its detection method using wavelet analysis. *IET Generation, Transmission, and Distribution*, 7(9), 982–990.
42. Madisetti, V., & Williams, D. (1999). *Digital signal processing handbook*. CRC Press.
43. He, S., Shen, X., & Jiang, Z. (2019). Detection and location of stator winding interturn fault at different slots of DFIG. *IEEE Access*, 7, 89342–89353.
44. Idrissi, I., El Bachtiri, R., Chafouk, H., & Khanfara, M. (2019). Fault diagnosis of stator inter-turn short circuit in doubly fed induction generator of wind turbine. In *6th International conference on control, decision and information technologies* (pp. 1313–1318), Paris, France.
45. Lu, Q., Breikin, T., & Wang, H. (2011). Modelling and fault diagnosis of stator inter-turn short circuit in doubly-fed induction generators. In *Proceedings of IFAC*, Milan, Italy.

46. Wang, C., & Weiss, G. (2014). Linear parameter varying control of a doubly fed induction generator based wind turbine with primary grid frequency support: LPV control of a DFIG-based wind turbine. *International Journal of Robust and Nonlinear Control*, 24(14), 1927–1946.
47. Guzmán, R., Vicuña, L., Castilla, M., Miret, J., & Camacho, A. (2017). Finite control set model predictive control for a three-phase shunt active power filter with a Kalman filter-based estimation. *Energies*, 10(10), 1553.
48. Razafimahefa, T., Bilal, H., Heraud, N., & Sambatra, E. (2019). Experimental and analytical approaches for investigating low-level inter-turn winding faults in induction machine. In *4th Conference on control and fault tolerant systems* (pp. 135–140), Casablanca, Morocco.
49. Wehner, M., & Ponick, B. (2014). *Search coil systems for early fault detection in wind turbine generators* (pp. 273–278). International Symposium on Power Electronics.
50. Nandi, S. (2008). Space and time harmonics related problems and their mitigation for position and speed sensorless slip-ring induction motor drives applications. *Sadhana*, 33(pt. 5), 565–580.
51. Gritli, Y., Stefani, A., Filippetti, F., & Chatti, A. (2009). Stator fault analysis based on wavelet technique for wind turbines equipped with DFIG. In *International conference on clean electrical power* (pp. 485–491), Capri, Italy.
52. Roshanfekar, R., & Jalilian, A. (2016). Wavelet-based index to discriminate between minor inter-turn short-circuit and resistive asymmetrical faults in stator windings of doubly fed induction generators: A simulation study. *IET Generation, Transmission, and Distribution*, 10(2), 374–381.
53. Kia, S., Henao, H., & Capolino, G. (2009). Diagnosis of broken-bar fault in induction machines using discrete wavelet transform without slip estimation. *IEEE Transactions on Industry Applications*, 45(4), 1395–1404.
54. Cheng, J., Ma, H., Song, S., & Xie, Z. (2018). Stator inter-turn fault analysis in doubly-fed induction generators using rotor current based on finite element analysis. In *IEEE international conference on progress in informatics and computing (PIC)* (pp. 414–419), Suzhou, China.
55. Ma, H., Zhang, Z., Ju, P., Shi, W., & Wang, C. (2015). Stator fault detection of doubly-fed induction generators using rotor instantaneous power spectrum. In *10th IEEE international symposium on diagnostics for electrical machines, power electronics and drives (SDMPED)* (pp. 165–170), Guarda.
56. Lu, Q., & Breikin, T. (2011). Fault detection for stator inter-turn short circuit in doubly fed induction generators using adaptive observers. *International Journal of Advanced Mechatronic Systems*, 3(1), 44–53.
57. Gritli, Y., Stefani, A., Rossi, C., Filippetti, F., & Chatti, A. (2010). Advanced doubly fed induction machine diagnosis under time-varying condition. In *XIX international conference on electrical machines* (pp. 1–7) Rome, Italy.
58. Ma, H., Zhang, Y., Li, S., Tang, Z., & Zhang, Z. (2017). Research on fault diagnosis of asymmetric stator winding for doubly-fed induction generators. In *IOP conference series: earth and environmental science* (Vol. 121, No. 4), Sanya, China.
59. Wang, L., et al. (2014). *Fault diagnosis based on current signature analysis for stator winding of Doubly fed induction generator in wind turbine* (pp. 233–236). International Symposium on Electrical Insulating Materials.
60. Kang, Y., Kang, H., & Lee, J. (2010). D-q equivalent circuit-based protection algorithm for a doubly-fed induction generator in the time domain. *The Journal of Electrical Engineering and technology*, 5(3), 371–378.
61. Stojčić, G., Pasanbegović, K., & Wolbank, T. M. (2014). Detecting faults in doubly fed induction generator by rotor side transient current measurement. *IEEE Transactions on Industry Applications*, 50(5), 3494–3502.
62. Djurović, S., Vilchis-Rodríguez, D., & Smith, A. C. (2012). Vibration monitoring for wound rotor induction machine winding fault detection. In *XXth international conference on electrical machines* (pp. 1906–1912), Marseille, France.
63. Djurović, S., Vilchis-Rodríguez, D. S., & Smith, A. C. (2014). Investigation of wound rotor induction machine vibration signal under stator electrical fault conditions. *The Journal of Engineering*, 2014(5), 248–258.
64. Qin, P., Zhang, Z., Sun, Y., Liu, H., & Ren, H. (2018). Vibration analysis of DFIG stator winding inter-turn short circuit fault. In *International conference on information systems and computer aided education (ICISCAE)* (pp. 436–442), Changchun, China.
65. Vilchis-Rodríguez, D., Djurović, S., Đukanović, S., & Smith, A. (2013). Analysis of wound rotor induction generator transient vibration signal under stator fault conditions. *European Wind Energy Conference and Exhibition, Vienna, Austria*, 3, 1930–1936.
66. Vilchis-Rodríguez, D., Djurović, S., Kung, P., Comanici, M., & Smith, A. C. (2014). Investigation of induction generator wide band vibration monitoring using fibre Bragg grating accelerometers. In *International conference on electrical machines (ICEM)* (pp. 1772–1778), Berlin, Germany.
67. Sarma, N., Li, Q., Djurović, S., Smith, A. C., & Rowland, S. M. (2013). Analysis of a wound rotor induction machine low frequency vibroacoustic emissions under stator winding fault conditions. In *8th IET international conference on power electronics, machines and drives (PEMD 2016)* (pp. 1–6), Glasgow, Scotland, UK..
68. Vu, H., Yahoui, H., & Hammouri, H. (2019). An experimental investigation of new electromagnetic field signal for stator asymmetric fault detection of doubly fed induction generators. *International Transactions on Electrical Energy Systems*, 29(6), e12019.
69. Qing, L., Li, M., & De-yan, W. (2011). Influence of stator turn-to-turn short-circuit on magnetic field of DFIG. In *International conference on electrical machines and systems (ICEMS)* (pp. 1–5), Beijing, China.
70. Li, J., Wang, D., Wang, X., & Zhang, L. (2014). Fault features study of doubly fed induction generators on the stator windings turn-to-turn short circuit. *Proceedings of the Second International Conference on Mechatronics and Automatic Control, Beijing, China*, 334, 29–38.
71. Faiz, J., Moosavi, S., Abadi, M., & Cruz, S. (2016). Magnetic equivalent circuit modelling of doubly-fed induction generator with assessment of rotor interturn short-circuit fault indices. *IET Renewable Power Generation*, 10(9), 1431–1440.
72. Abad, G., Lopez, J., Rodriguez, M., Marroyo, L., & Iwanski, G. (2011). *Doubly fed induction machine: Modeling and control for wind energy generation*. Wiley.
73. Fan, L., Yuvarajan, S., & Kavasserri, R. (2010). Harmonic analysis of a DFIG for a wind energy conversion system. *IEEE Transaction Energy Conversion*, 25(1), 181–190.
74. Djurović, S., Crabtree, C. J., Tavner, P. J., & Smith, A. C. (2012). Condition monitoring of wind turbine induction generators with rotor electrical asymmetry. *IET Renewable Power Generation*, 6(4), 207–216.
75. Salah, A. A., & Dorrell, D. G. (2019). Operating induction machine in DFIG mode including rotor asymmetry. In *South African universities power engineering conference/robotics and mechatronics/pattern recognition association of South Africa (SAUPEC/RobMech/PRASA)*, Bloemfontein (pp. 469–474).
76. Yazidi, A., Henao, H., Capolino, G. A., & Betin, F. (2010). Rotor inter-turn short circuit fault detection in wound rotor induction machines. In *The XIX international conference on electrical machines—ICEM 2010* (pp. 1–6), Rome, Italy.
77. Li, J.-q., Dong, W., & Long, H. (2013). Study of rotor winding inter-turn short circuit fault in doubly fed induction generator based on current signal spectrum analysis. In *International conference on electrical machines and systems (ICEMS)* (pp. 789–792), Busan, Korea.
78. Cusido, J., Romeral, L., Ortega, J. A., Rosero, J. A., & Espinosa, A. G. (2008). Fault detection in induction machines using power spectral density in wavelet decomposition. *IEEE Transactions on Industrial Electronics*, 55(2), 633–643.
79. Ibrahim, R., Watson, S., Djurović, S., & Crabtree, C. J. (2018). An effective approach for rotor electrical asymmetry detection in wind turbine DFIGs. *IEEE Transactions on Industrial Electronics*, 65(11), 8872–8881.
80. Hashemi, Z., & Rahideh, A. (2020). Rotor electrical fault detection of wind turbine induction generators using an unscented Kalman filter. *Iranian Journal of Science and Technology, Transactions of Electrical Engineering*, 4(2), 979–988.
81. Sabir, H., Ouassaid, M., & Ngote, N. (2018). Diagnosis of rotor winding inter-turn short circuit fault in wind turbine based on DFIG using hybrid TSADWT approach. In *6th International renewable and sustainable energy conference (IRSEC)* (pp. 1–6), Rabat.
82. Sabir, H., Ouassaid, M., & Ngote, N. (2019). Rotor winding failure diagnosis in wind turbine based on DFIG using the PSD-TSA method. In *8th International conference on systems and control (ICSC)* (pp. 366–37), Marrakesh, Morocco.
83. Zappalá, D., Sarma, N., Djurović, S., Crabtree, C., Mohammad, A., & Tavner, P. (2019). Electrical and mechanical diagnostic indicators of wind

- turbine induction generator rotor faults. *Renewable Energy, Elsevier*, 131, 14–24.
84. Moosavi, S., Faiz, J., Abadi, M., & Cruz, S. (2019). Comparison of rotor electrical fault indices owing to inter-turn short circuit and unbalanced resistance in doubly-fed induction generator. *IET Electric Power Applications*, 13(2), 235–242.
  85. Djurović, S., & Williamson, S. (2010). Investigation of the impact of speed-ripple and inertia on the steady-state current spectrum of a DFIG with unbalanced rotor. In *5th IET international conference on power electronics, machines and drives (PEMD 2010)* (pp. 1–6) Brighton, UK.
  86. Dinkhauser, V., & Fuchs, F. W. (2008). Rotor turn-to-turn faults of doubly-fed induction generators in wind energy plants-modelling, simulation and detection. In *13th International power electronics and motion control conference* (pp. 819–1826), Poznan.
  87. Dinkhauser, V., & Fuchs, F. W. (2009). *Rotor turn-to-turn fault detection in doubly-fed induction machines by means of state space modeling and Luenberger observer* (pp. 1–8). IEEE International Symposium on Diagnostics for Electric Machines.
  88. Brigham, K., Zappalá, D., Crabtree, C., & Donaghy-Spargo, C. (2020). Simplified automatic fault detection in wind turbine induction generators. *Wind Energy Journal*, 23(4), 1135–1144.
  89. Gritli, Y., Zari, L., Rossi, C., Filippetti, F., Capolino, G., & Casadei, D. (2013). Advanced diagnosis of electrical faults in wound-rotor induction machines. *IEEE Transactions on Industrial Electronics*, 60(9), 4012–4024.
  90. Gritli, Y., Stefani, A., Rossi, C., Filippetti, F., Chatti, A., & Zari, L. (2010). Experimental validation of doubly fed induction machine rotor fault diagnosis based on wavelet analysis in closed-loop operations. In *International symposium on power electronics, electrical drives, automation and motion (SPEEDAM 2010)* (pp. 513–518) Pisa.
  91. Junqing, L., Long, H., & Dong, W. (2013). Rotor winding inter-turn fault analysis of doubly-fed induction generator based on negative sequence component. In *International conference on electrical machines and systems (ICEMS)* (pp. 785–788), Busan, South Korea.
  92. Rehman, A. U. et al. (2016). Experimental research and analysis on rotor winding inter-turn short circuit fault in DFIG. In *2016 International conference on condition monitoring and diagnosis* (pp. 164–167), Xi'an, China.
  93. Ur Rehman, A., Chen, Y., Wang, L., Zhao, Y., Cheng, Y., & Tanaka, T. (2016). Simulation using MATLAB/Simulink on rotor winding inter-turn short circuit fault in DFIG. In *IEEE international conference on dielectrics (ICD)* (pp. 506–509), Montpellier, France.
  94. Rehman, A., Chen, Y., Zhao, Y., Cheng, Y., Zhao, Y., & Tanaka, T. (2018). Detection of rotor inter-turn short circuit fault in doubly-fed induction generator using FEM simulation. In *2nd IEEE international conference on dielectrics (ICD)* (pp. 1–4), Budapest, Hungary.
  95. Zaggout, M., Tavner, P., Crabtree, C., & Ran, L. (2014). Detection of rotor electrical asymmetry in wind turbine doubly-fed induction generators. *IET Renewable Power Generation*, 8(8), 878–886.
  96. Sapeña-Bano, A., Riera-Guasp, M., Puche-Panadero, R., Martínez-Roman, J., Pérez-Cruz, J., & Pineda-Sánchez, M. (2016). Harmonic order tracking analysis: A speed-sensorless method for condition monitoring of wound rotor induction generators. *IEEE Transactions on Industry Applications*, 52(6), 4719–4729.
  97. Gritli, Y., Rossi, C., Casadei, D., Filippetti, F., Bellini, A., & Capolino, G. (2015). A new reliable fault index for rotor dissymmetry detection in wound-rotor induction machine. In *10th IEEE international symposium on diagnostics for electrical machines, power electronics and drives (SDEMPED)* (pp. 468–473), Guarda.
  98. Gritli, Y., Rossi, C., Casadei, D., Filippetti, F., & Capolino, G. (2017). A diagnostic space vector-based index for rotor electrical fault detection in wound-rotor induction machines under speed transient. *IEEE Transactions on Industrial Electronics*, 64(5), 3892–3902.
  99. Dinkhauser, V., & Fuchs, F. W. (2009). Detection of rotor turn-to-turn faults in doubly-fed induction generators in wind energy plants by means of observers. In *13th European conference on power electronics and applications* (pp. 1–10), Barcelona, Spain.
  100. Rehman, A., Chen, Y., Zhang, M., et al. (2020). Fault detection and fault severity calculation for rotor windings based on spectral, wavelet and ratio computation analyses of rotor current signals for a doubly fed induction generator in wind turbines. *The Journal of Electrical Engineering*, 102(4), 1091–1102.
  101. Dameshghi, A., & Refan, M. (2019). Combination of condition monitoring and prognosis systems based on current measurement and PSO-LS-SVM method for wind turbine DFIGs with rotor electrical asymmetry. *The Journal of Energy systems*, 12, 203.
  102. Antonino-Daviu, J., Quijano-López, A., Climente-Alarcon, V., & Garín-Abellán, C. (2017). Reliable detection of rotor winding asymmetries in wound rotor induction motors via integral current analysis. *IEEE Transactions on Industry Applications*, 53(3), 2040–2048.
  103. Vedreño Santos, F. J. (2013). *Diagnosis of electric induction machines in non-stationary regimes working in randomly changing conditions*. PhD dissertation, Universitat Politècnica de Valencia, Valencia, Spain.
  104. Antonino-Daviu, J., Climente-Alarcon, V., Tsoumas, I., Georgoulas, G., & Pérez, R. B. (2013). Multi-harmonic tracking for diagnosis of rotor asymmetries in wound rotor induction motors. In *39th Annual conference of the IEEE Industrial Electronics Society, IECON 2013* (pp. 5555–5560), Vienna.
  105. Yang, W., Tavner, P. J., Crabtree, C. J., & Wilkinson, M. (2010). Cost-effective condition monitoring for wind turbines. *IEEE Transactions on Industrial Electronics*, 57(1), 263–271.
  106. Yucai, W., & Yonggang, L. (2015). Diagnosis of rotor winding interturn short-circuit in turbine generators using virtual power. *IEEE Transactions on Energy Conversion*, 30(1), 183–188.
  107. Liu, Z., Cao, W., Tan, Z., Song, X., Ji, B., & Tian, G. (2013). Electromagnetic and temperature field analyses of winding short-circuits in DFIGs. In *9th IEEE international symposium on diagnostics for electric machines, power electronics and drives (SDEMPED)* (pp. 269–273), Valencia.
  108. Jun-qing, L., & Xi-mei, W. (2013). FEM analysis on interturn fault of rotor winding in DFIG. In *International conference on electrical machines and systems (ICEMS)* (pp. 797–802), Busan, Korea.
  109. Vilchis-Rodríguez, D. S., Djurović, S., Sarma, N., Tshiloz, K., Smith, A. C., & Wei, Y. (2016). On wound rotor induction machine rotor electrical unbalance recognition using stator frame vibration spectral analysis. In *8th IET international conference on power electronics, machines and drives (PEMD 2016)* (pp. 1–7), Glasgow, UK.
  110. Yan-jun, Z., Yong-gang, L., & Ji-wei, H. (2008). RBFNN for fault diagnosis of rotor windings inter-turn short circuit in turbine-Generator. In *International conference on condition monitoring and diagnosis* (pp. 1331–1334), Beijing, China.
  111. Abadi, M., Cruz, S., Gonçalves, A., Gonçalves, P., Mendes, A., Ribeiro, A., & Silva, F. (2014). Detection of stator and rotor faults in a DFIG based on the stator reactive power analysis. In *40th Annual conference of the IEEE industrial electronics society (IECON 2014)* (pp. 2037–2043), Dallas.
  112. Abadi, M., Cruz, S., Gonçalves, A., Mendes, A., Ribeiro, A., & Silva, F. (2014). Inter-turn fault detection in doubly-fed induction generators for wind turbine applications using the stator reactive power analysis. In *3rd Renewable power generation conference (RPG 2014)* (pp. 1–6), Naples.
  113. Vedreño-Santos, F., Riera-Guasp, M., Henao, H., Pineda-Sánchez, M., & Puche-Panadero, R. (2014). Diagnosis of rotor and stator asymmetries in wound-rotor induction machines under nonstationary operation through the instantaneous frequency. *IEEE Transactions on Industrial Electronics*, 61(9), 4947–4959.
  114. Swana, E. F., & Doorsamy, W. (2018). Fault diagnosis on a wound rotor induction generator using probabilistic intelligence. In *IEEE international conference on environment and electrical engineering and IEEE industrial and commercial power systems Europe (EEEIC / I&CPS Europe)* (pp. 1–5), Palermo, Italy.
  115. Casadei, D., Filippetti, F., Rossi, C., Stefani, A., Yazidi, A., & Capolino, G. (2006). Diagnostic technique based on rotor modulating signals signature analysis for doubly fed induction machines in wind generator systems. In *IEEE forty-first industry applications society annual meeting conference* (pp. 1525–1532), Tampa, Florida, USA.
  116. Stefani, A., Yazidi, A., Rossi, C., Filippetti, F., Casadei, D., & Capolino, G. (2008). Doubly fed induction machines diagnosis based on signature analysis of rotor modulating signals. *IEEE Transactions on Industry Applications*, 44(6), 1711–1721.
  117. Casadei, D., Filippetti, F., Rossi, C., & Stefani, A. (2008). Closed loop bandwidth impact on doubly fed induction machine asymmetries detection based on rotor voltage signature analysis. In *43rd International universities power engineering conference* (pp. 1–5), Padova.
  118. Yu, W., Jiang, D., Wang, J., Li, R., & Yang, L. (2020). Rotor-current-based fault detection for doubly-fed induction generator using new sliding

- mode observer. *Transactions of the Institute of Measurement and Control*, 42, 3110–3122.
119. Yazidi, A., Capolino, G. A., Filippetti, F., & Casadei, D. (2006). A new monitoring system for wind turbines with doubly-fed induction generators. In *IEEE mediterranean electrotechnical conference (MELECON 2006)* (pp. 1142–1145), Malaga.
  120. Capocchi, L., Federici, D., Yazidi, A., Henao, H., & Capolino, G. A. (2008). Asymmetrical behavior of a double-fed induction generator: Modeling, discrete event simulation and validation. In *14th IEEE mediterranean electrotechnical conference (MELECON 2008)* (pp. 465–471), Ajaccio.
  121. Roshanfekar, R., Aliakbar, H., & Jalilian, A. (2014). Performance analysis of 3-phase wound rotor induction motor under asymmetrical fault conditions in stator and rotor windings. In *5th Annual international power electronics, drive systems and technologies conference (PEDSTC 2014)* (pp. 323–328) Tehran.
  122. Roshanfekar, R., & Jalilian, A. (2015). Analysis of rotor and stator winding inter-turn faults in WRIM using simulated MEC model and experimental results. *Electric Power Systems Research*, 119, 418–424.
  123. Swana, E., & Doorsamy, W. (2019). Investigation of combined electrical modalities for fault diagnosis on a wound-rotor induction generator. *IEEE Access*, 7, 32333–32342.
  124. Yazidi, A., Henao, H., Capolino, G. A., Artioli, M., Filippetti, F., & Casadei, D. (2005). *Flux signature analysis: An alternative method for the fault diagnosis of induction machines* (pp. 1–6). IEEE Russia Power Technology.
  125. Toma, S., Capocchi, L., & Capolino, G. (2013). Wound-rotor induction generator inter-turn short-circuits diagnosis using a new digital neural network. *IEEE Transactions on Industrial Electronics*, 60(9), 4043–4052.
  126. Swana, E. F., & Doorsamy, W. (2021). An unsupervised learning approach to condition assessment on a wound-rotor induction generator. *Energies*, 14(3), 602.

**Submit your manuscript to a SpringerOpen<sup>®</sup> journal and benefit from:**

- ▶ Convenient online submission
- ▶ Rigorous peer review
- ▶ Open access: articles freely available online
- ▶ High visibility within the field
- ▶ Retaining the copyright to your article

---

Submit your next manuscript at ▶ [springeropen.com](https://www.springeropen.com)

---